

Santo 58371

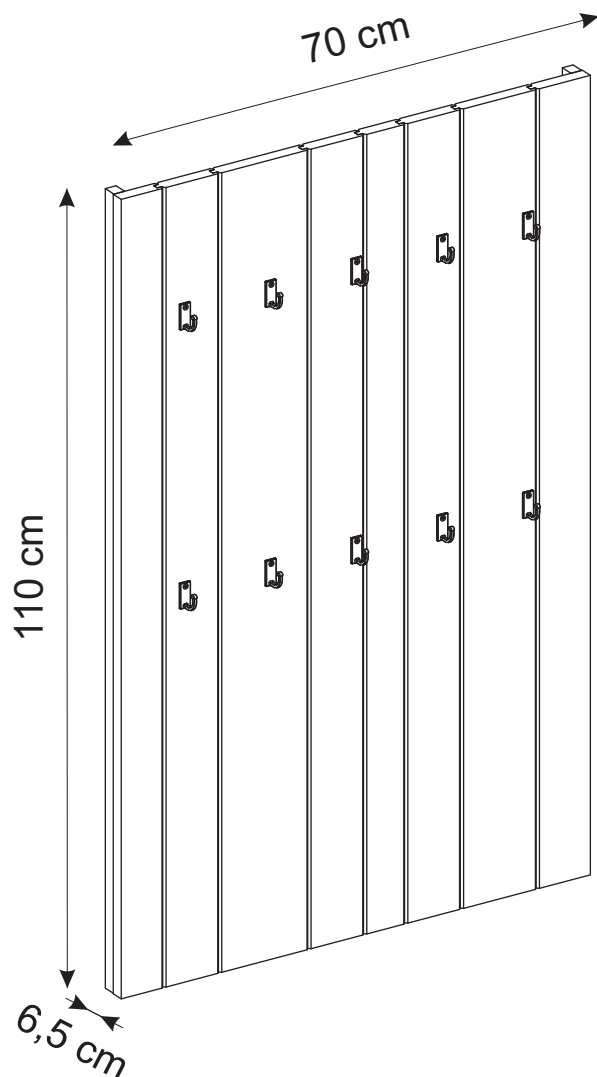

(D) Montageanleitung
68371

(GB) Assembly instructions
68371

(FR) Notice de montage
68371

(IT) Istruzioni di montaggio
68371

(NL) Handleiding voor de montage
68371

(PL) Instrukcja montażu
68371

(CZ) Montážní návod
68371

(SK) Návod na montáž
68371

(HU) Szerelési útmutató
68371

(RO) Instrucțiuni de montaj
68371

(TR) Montaj talimatı
68371

(RU) Инструкция по монтажу
68371

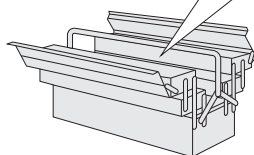
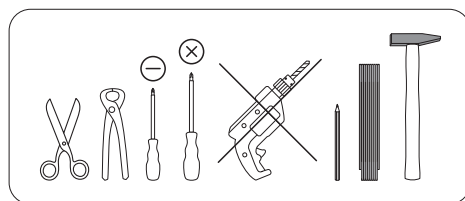
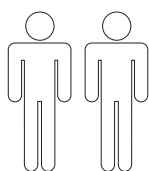

0
10
20
30
40
50
60
70
80
90
100
110
120
130
140
150
160
170
180
190
200

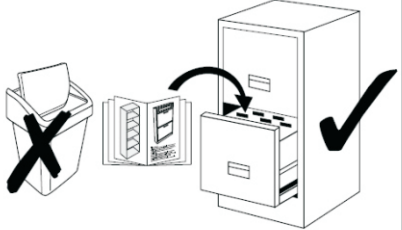
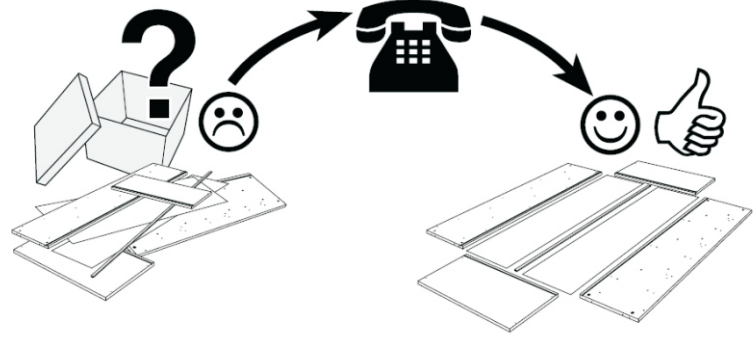
Service • Assistenza • Dienstverlening • Serwis Servis • Szerviz • Сервисная служба	
Name • Nom • Nome • Naam • Nazwa • Jméno • Názov • Név • Denumire • Ísim • Название	
Nr. • No. • N° • Номер • Č • Sz	
Typ • Type • Típus • Típus • Tipo • Тип	
	
	

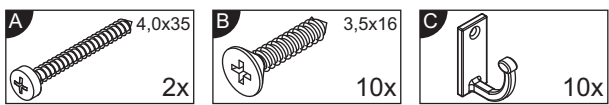
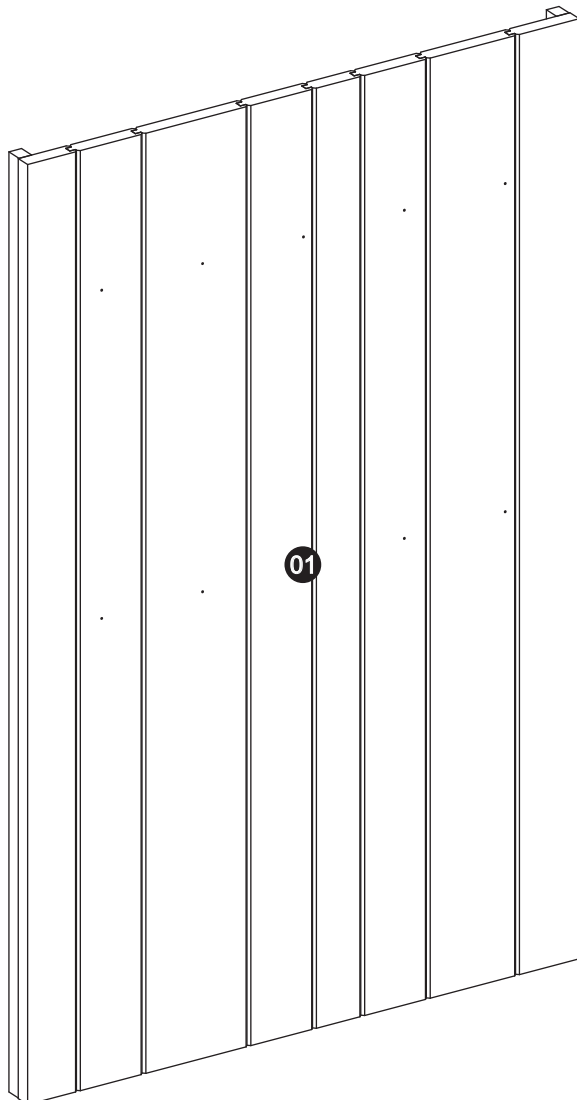

1

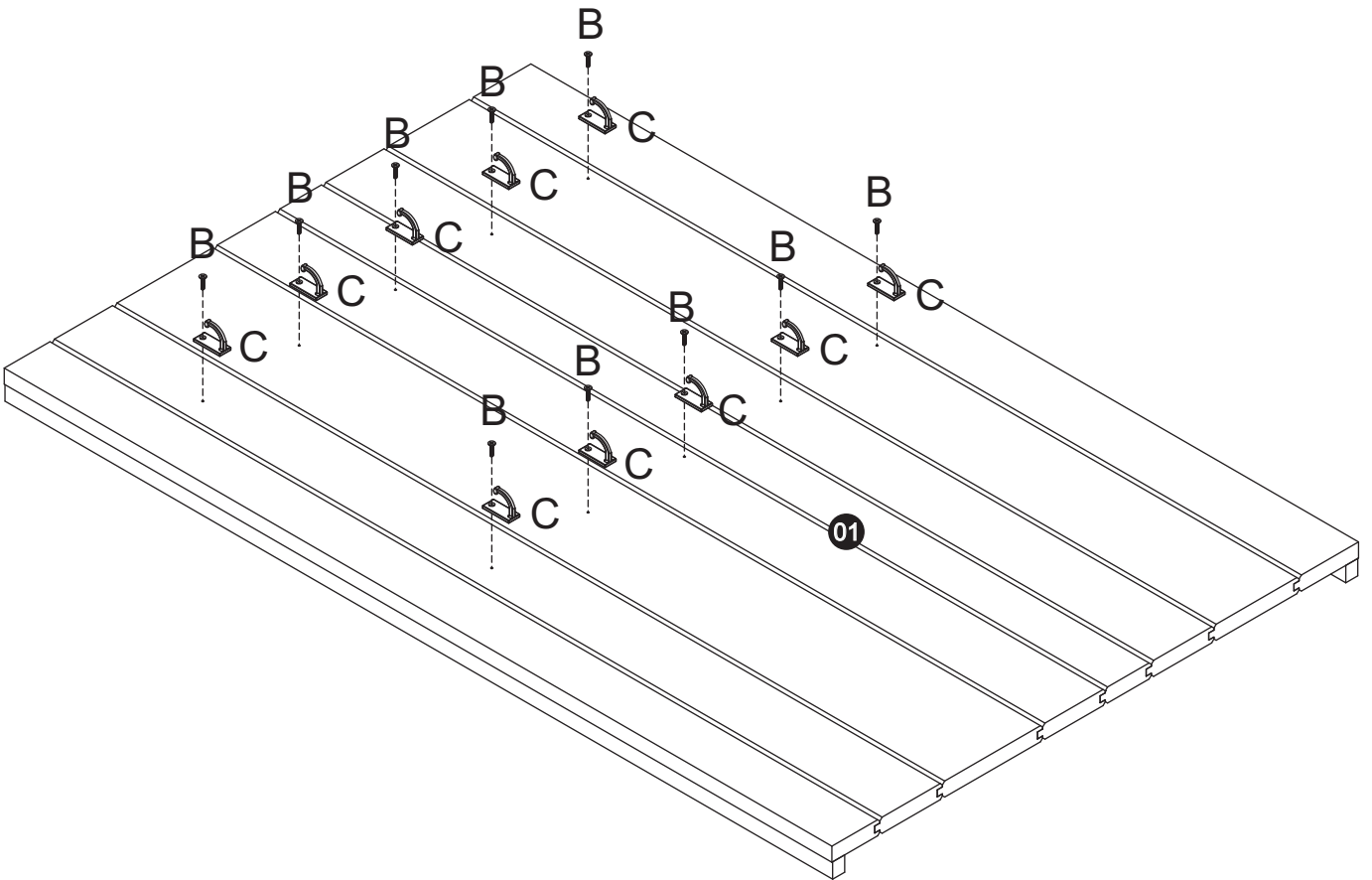
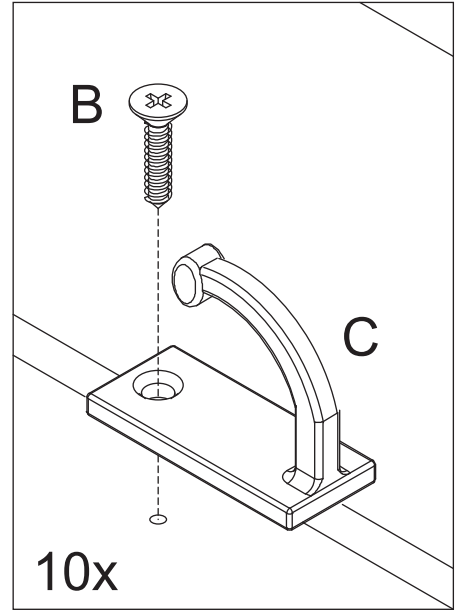
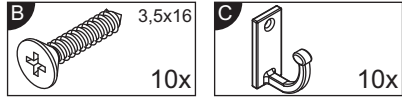

2

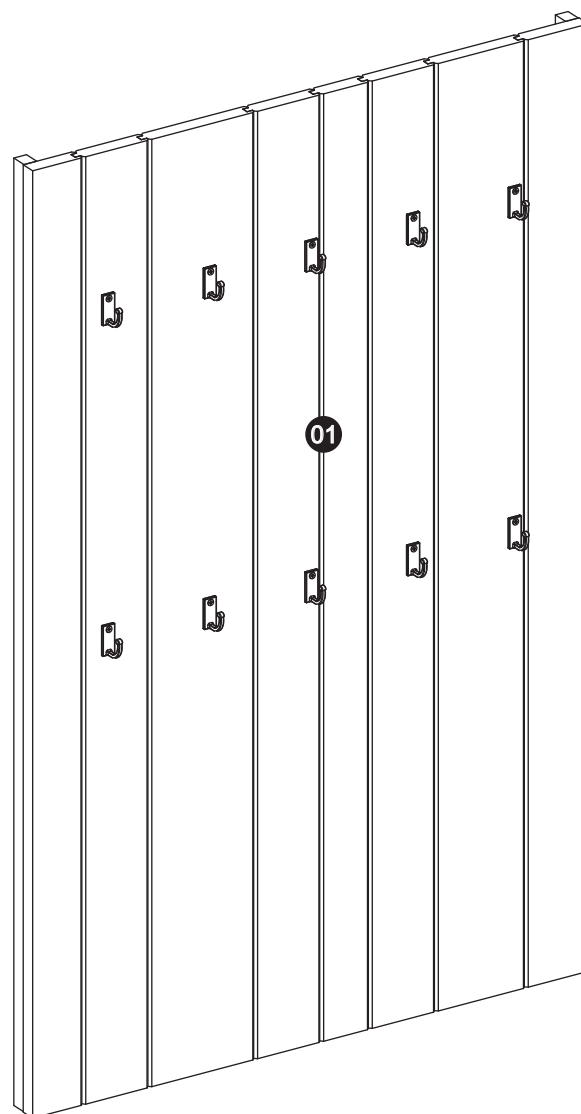
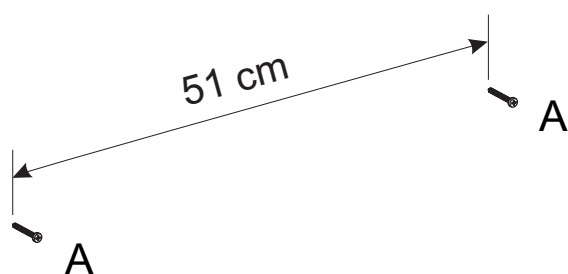
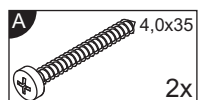

Achtung • Attention • Attenzione • Opgelet • Uwaga • Pozor • Figyelem • Atenție • Dikkat • Внимание	
(D)	Bei einigen Wandtypen kann ein Spezialdübel erforderlich sein!
(GB)	For certain wall types, a special dowel may be necessary!
(NL)	Bij enkele muurtypen is een speciale plug misschien vereist!
(PL)	Do niektórych rodzajów ścian konieczne mogą być specjalne wkręty!
(TR)	Bazı duvar tiplerinde bunun için özel bir dübel gerekli olabilir!
(RU)	Для некоторых типов стен может потребоваться специальный дюбель!
(FR)	Pour certains types de murs il faut des chevilles spéciales !
(IT)	Per alcune strutture di parete può essere necessario un tassello speciale!
(CZ)	U některých typů stěn může být zapotřebí speciální hmoždinka!
(SK)	Pre niektoré druhy stien môže byť potrebná špeciálna hmoždinka!
(HU)	Egyes fal típusoknál speciális tiplít kell használni!
(RO)	Pentru unele tipuri de pereți este posibil să fie necesar un diblu special!