

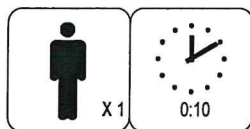

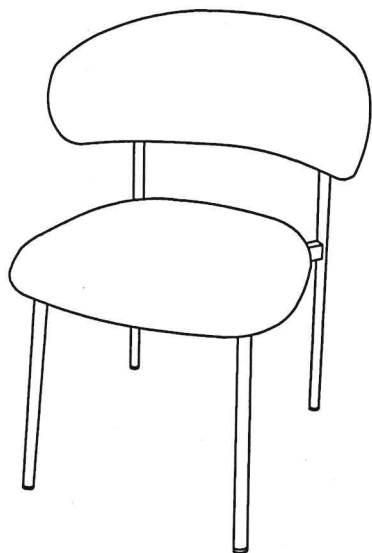





ASSEMBLY INSTRUCTIONS

DINING CHAIR MODEL#: UDC23014



 ① X 1	 ② X 1	 ③ X 1	
 A M6*35 X 2	 B M6*18 X 4	 C X 6	 D X 1

1

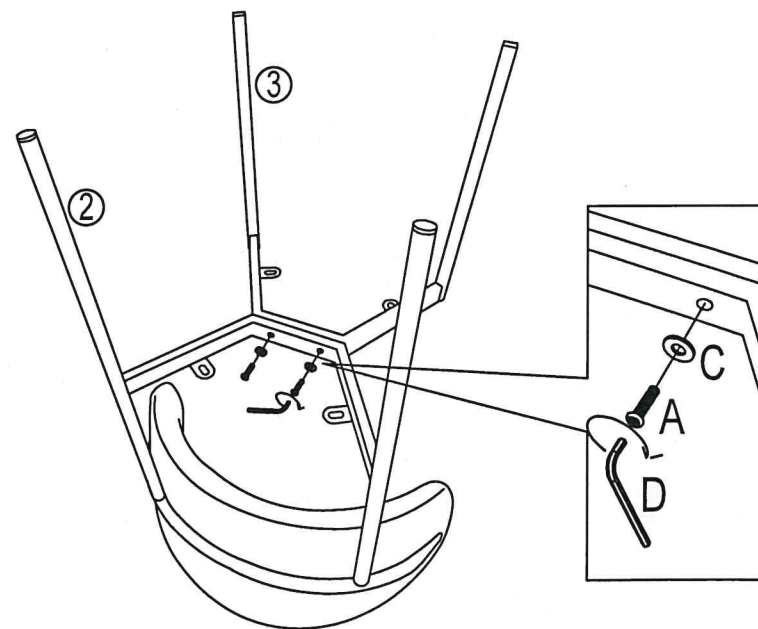

2

