

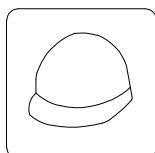

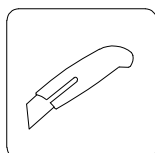

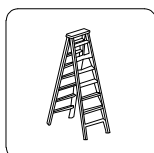

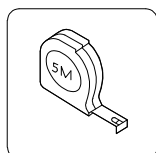

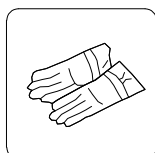
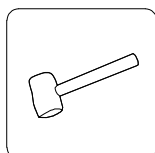
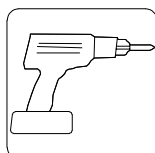
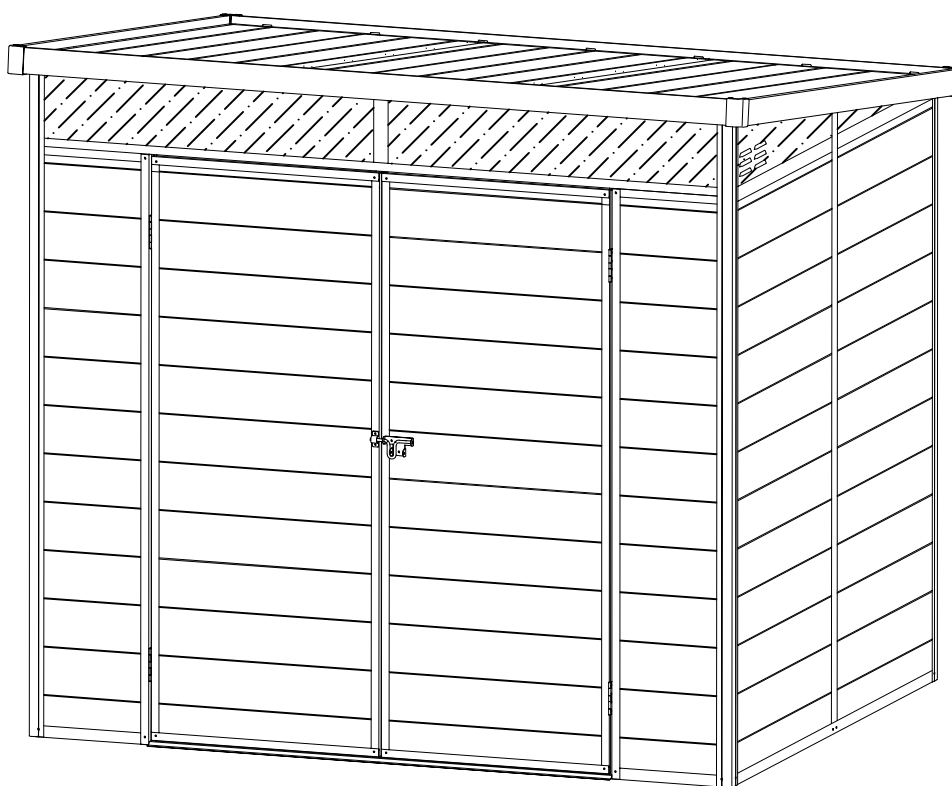
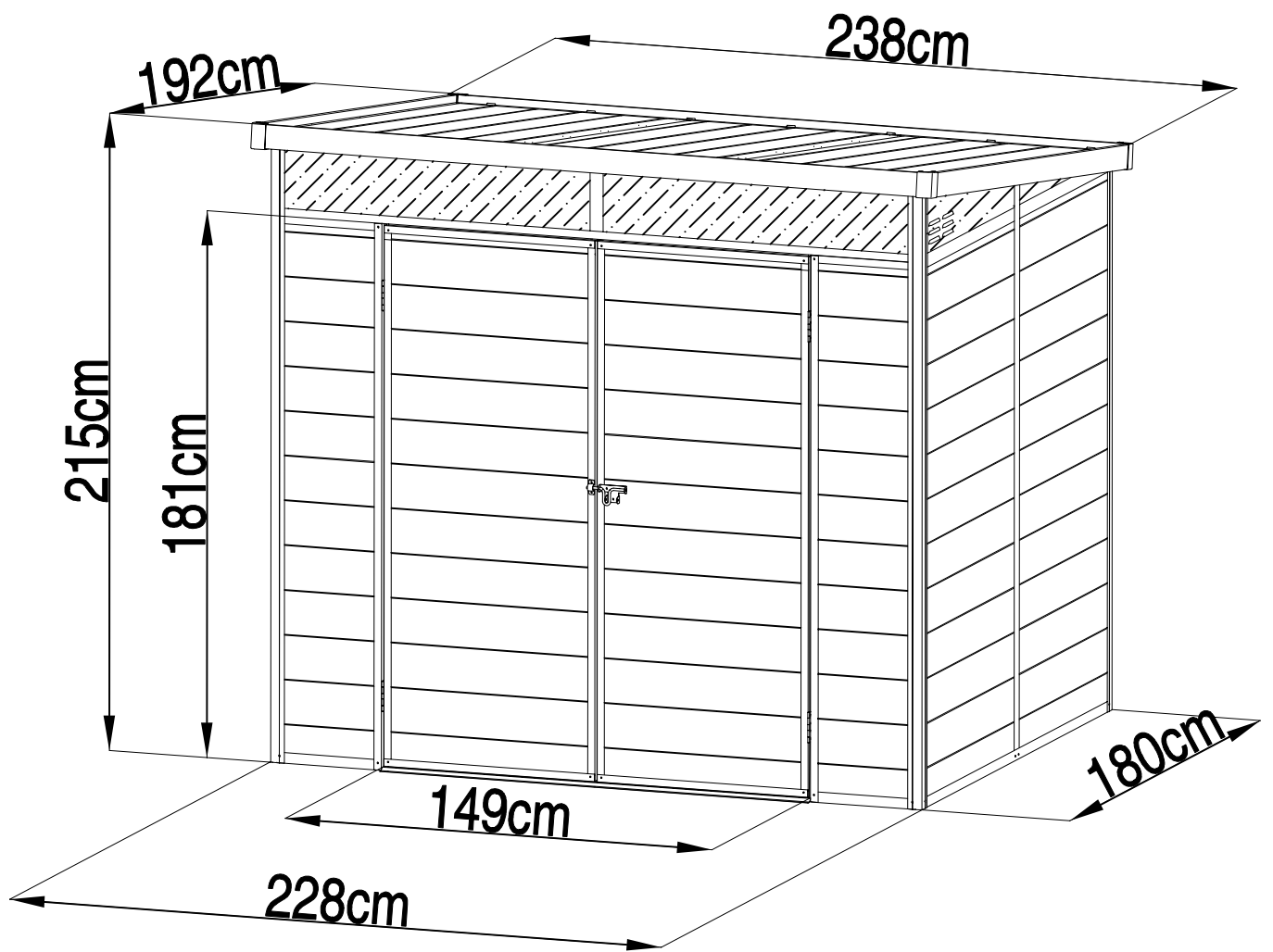
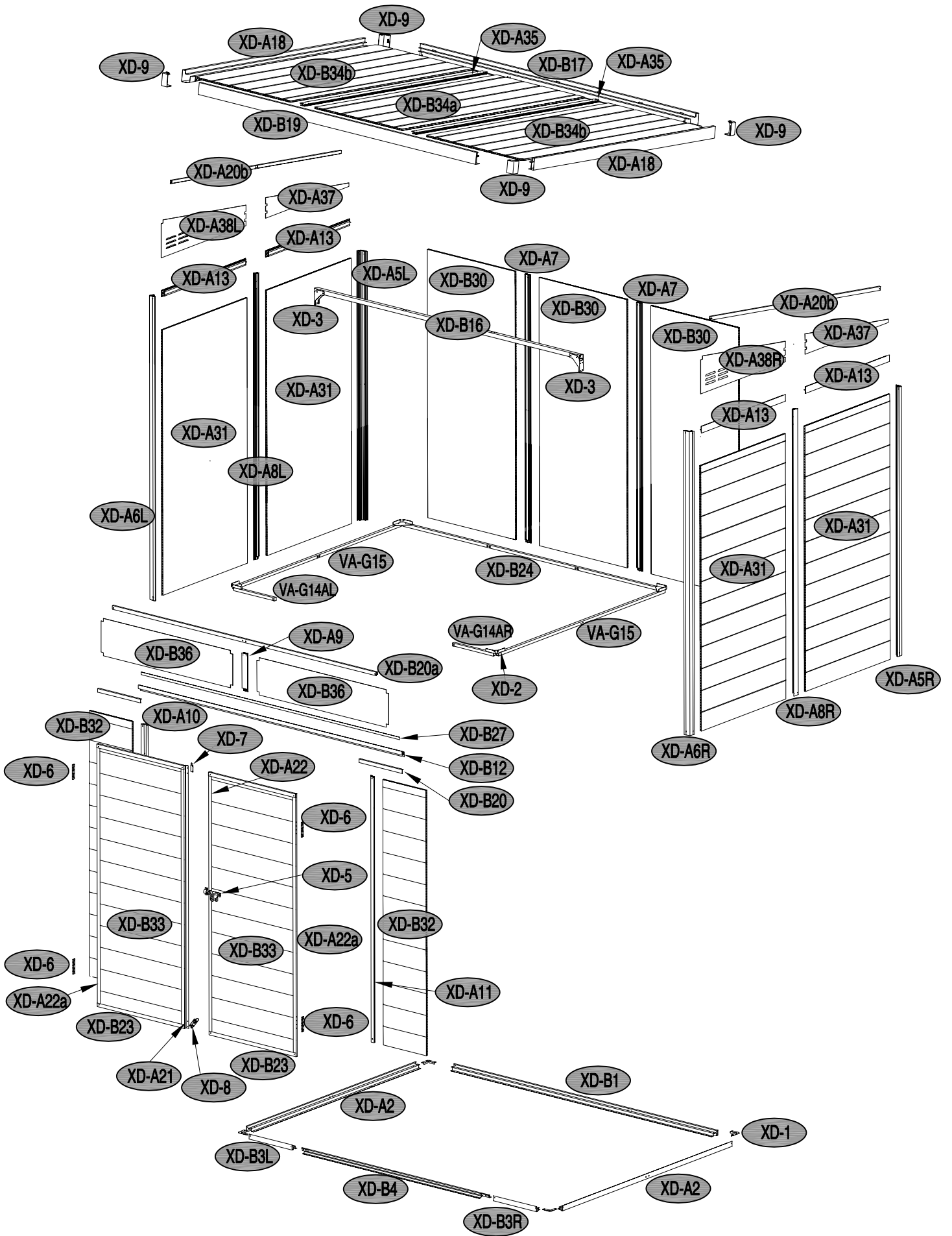



















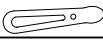























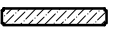

ZAHRADNÍ DOMEK Toya-B





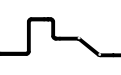

REF	IMAGE	QTY	REF	IMAGE	QTY
XD-B1		x1	XD-A38L		x1
XD-A2		x2	XD-A38R		x1
XD-B3L		x1	XD-1		x4
XD-B3R		x1	XD-2		x4
XD-B4		x1	XD-3		x2
XD-A5L		x1	XD-5		x1
XD-A5R		x1	XD-6		x4
XD-A6L		x1	XD-7		x1
XD-A6R		x1	XD-8		x1
XD-A7		x2	XD-9		x4
XD-A8L		x1	XD-10a		x1
XD-A8R		x1	VA-43		x2
XD-A9		x1	PA01		x3
XD-A10		x1	M-23		x2
XD-A11		x1	CN-A33		x2
XD-B12		x1	XD-B50		x276
XD-A13		x4	XD-B51		x3
XD-B16		x1	XD-B52		x2
XD-B17		x1	XD-B53		x16
XD-A18		x2	XD-B54		x16
XD-B19		x1	XD-B55		x12
XD-B20		x2	XD-B56		x4
XD-B20a		x1	XD-B57		x2
XD-A20b		x2	XD-B58		x2
XD-A21		x1	XD-B59		x4
XD-A22		x1			
XD-A22a		x2			
XD-B23		x4			
XD-B24		x1			
VA-G15		x2			
VA-G14AL		x1			
VA-G14AR		x1			
XD-B27		x1			
XD-B30		x3			
XD-A31		x4			
XD-B32		x2			
XD-B33		x2			
XD-B34a		x1			
XD-B34b		x2			
XD-A35		x2			
XD-B36		x2			
XD-A37		x2			

1	 XD-B1 x1	 XD-A2 x2	 XD-B3L x1	 XD-B3R x1	 XD-B4 x1	 XD-1 x4	 XD-B50 x20
----------	---	---	--	--	--	--	---

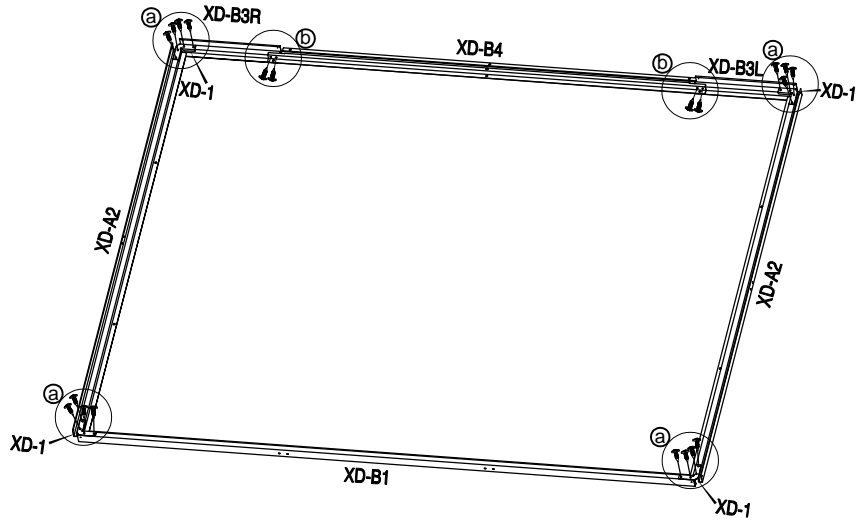
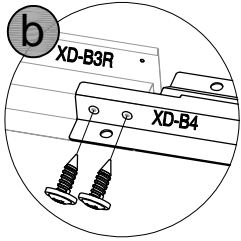
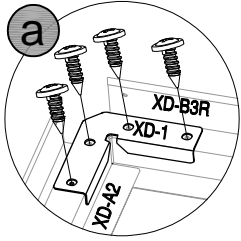

2	 XD-A5L x1						
----------	--	--	--	--	--	--	--

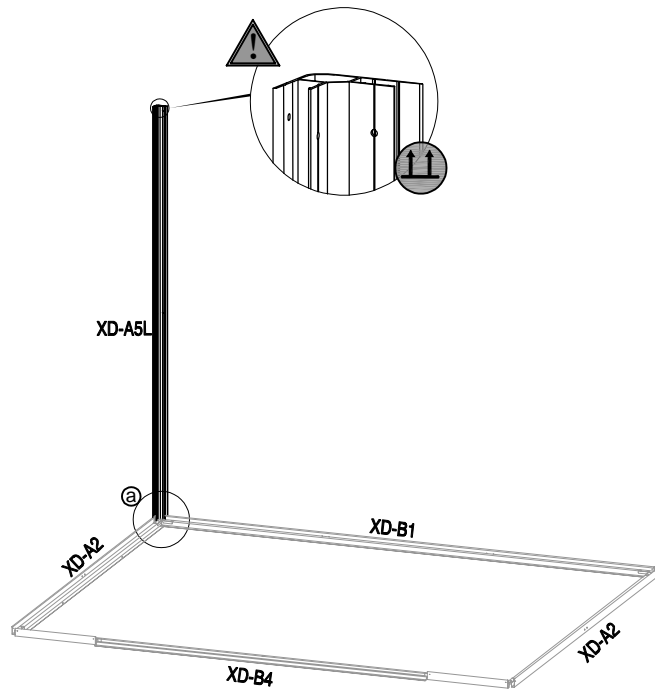
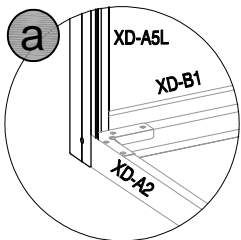
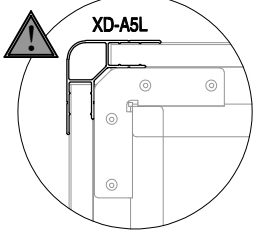



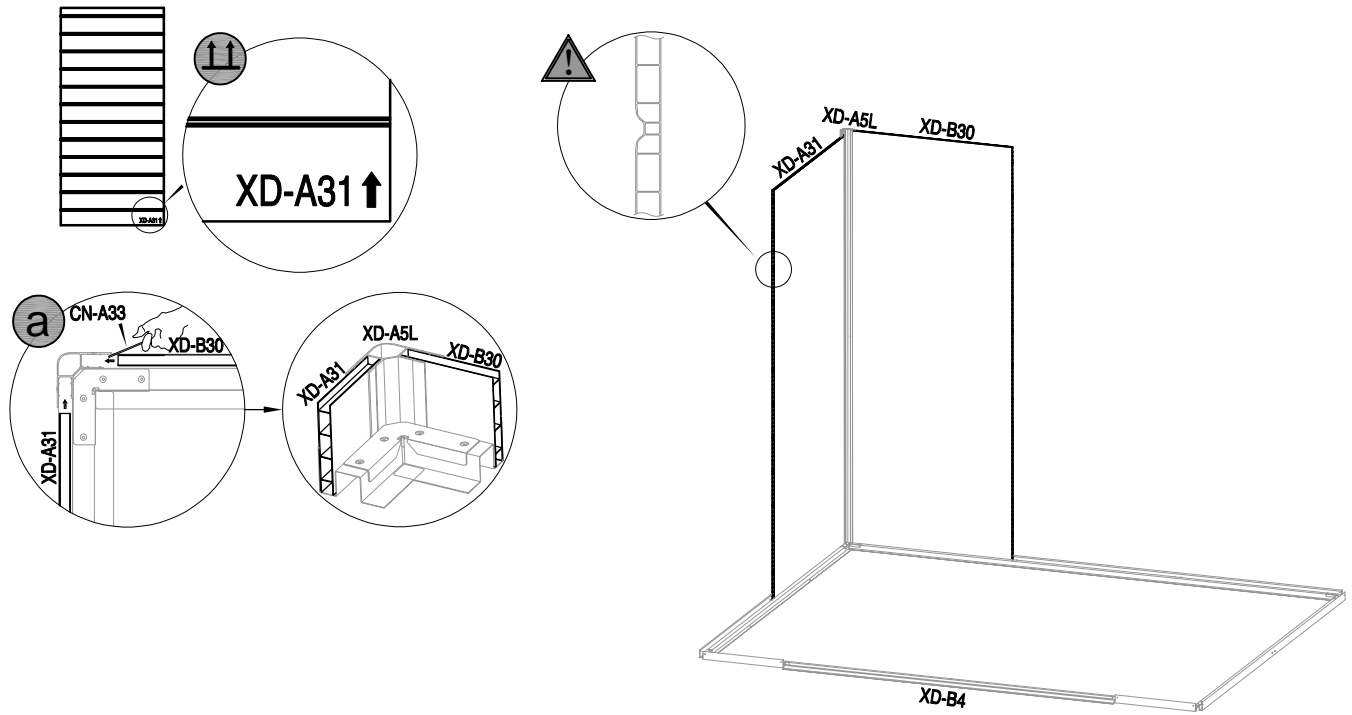

3	 XD-B30 x1	 XD-A31 x1					 CN-A33
---	--	--	--	--	--	--	---

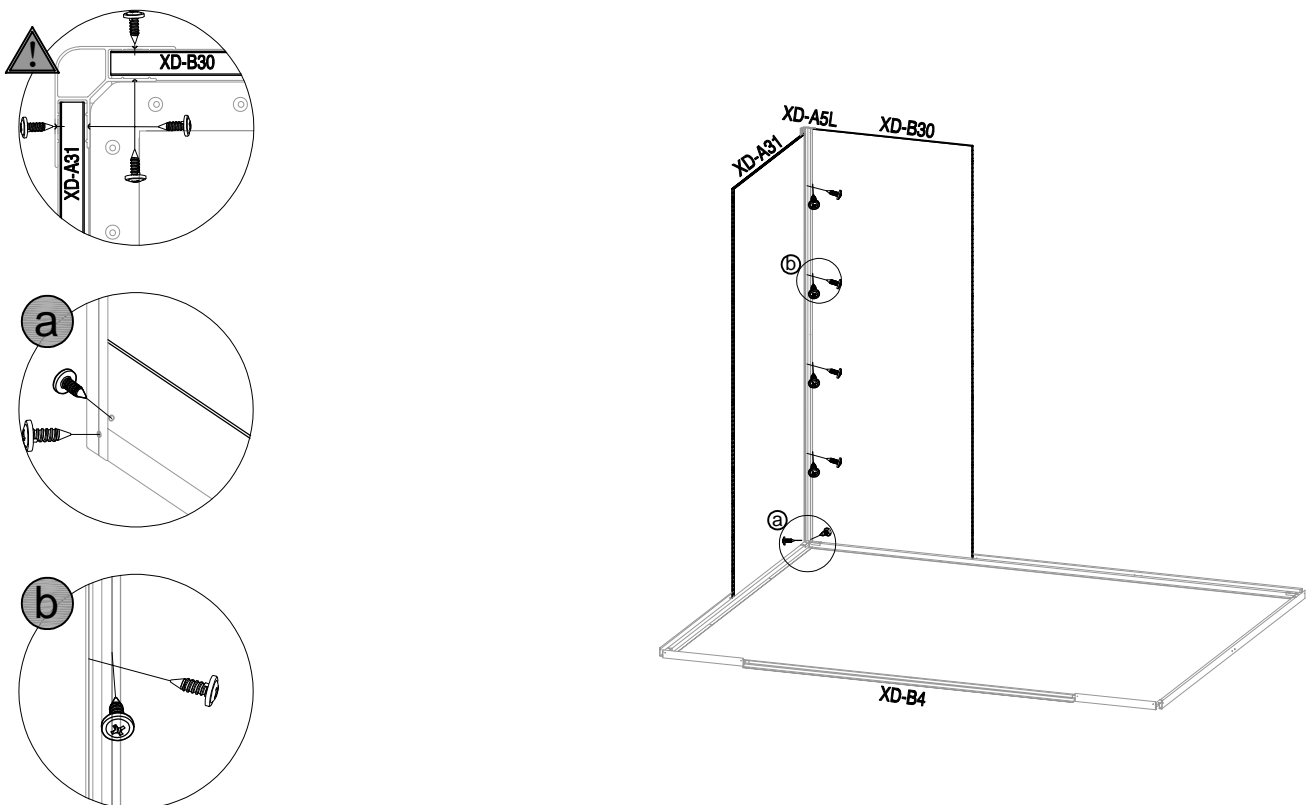





4	 XD-B50 x10						
---	---	--	--	--	--	--	--

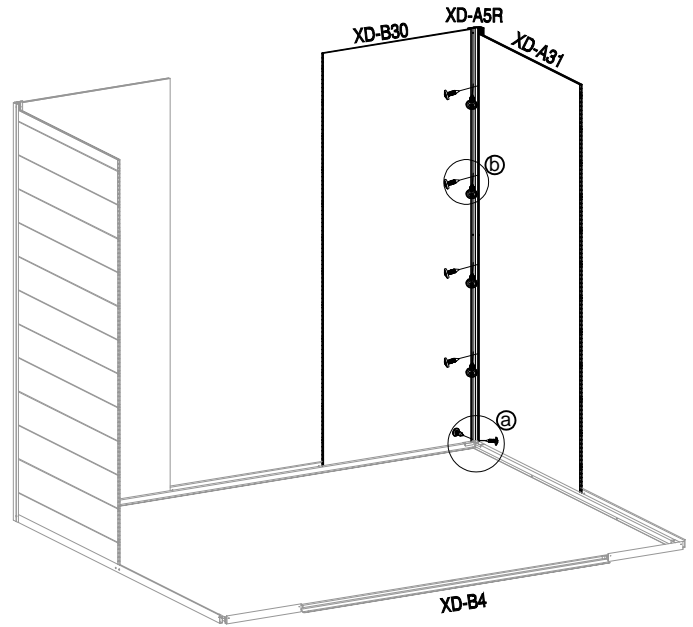
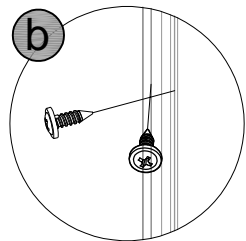
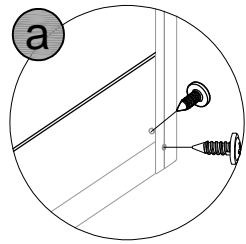
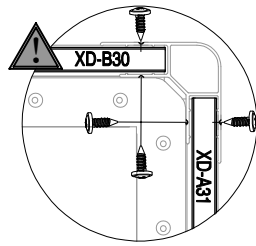
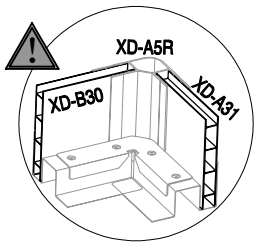





5	 XD-A5R x1	 XD-B30 x1	 XD-A31 x1	 XD-B50 x10			 CN-A33
---	--	--	--	---	--	--	---

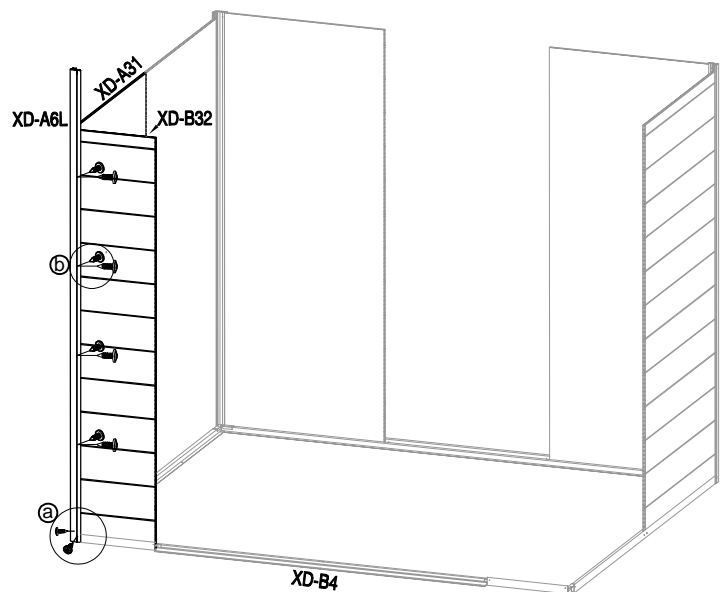
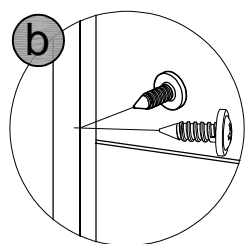
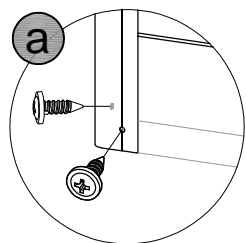
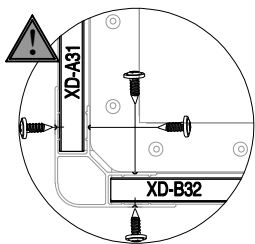

6	 XD-A6L x1	 XD-A31 x1	 XD-B32 x1	 XD-B50 x10			 CN-A33
---	--	--	--	---	--	--	---



7	 XD-A6R x1	 XD-A31 x1	 XD-B32 x1	 XD-B50 x10			 CN-A33
---	--	--	--	---	--	--	---

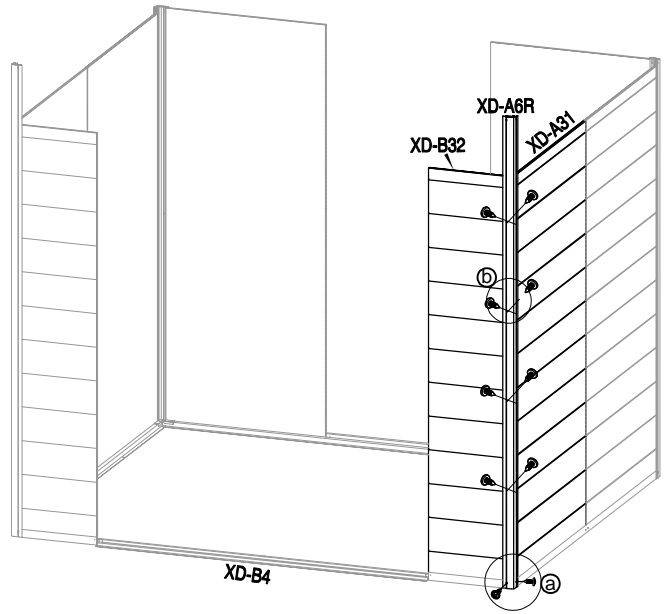
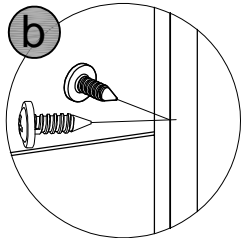
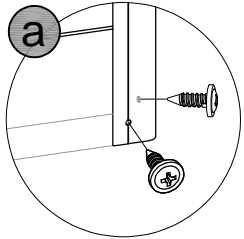
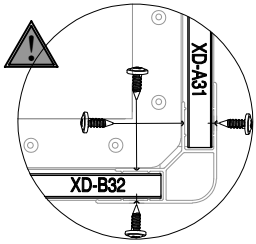

8	 XD-A8L x1	 XD-A8R x1	 XD-B50 x20				 CN-A33
---	--	--	---	--	--	--	---

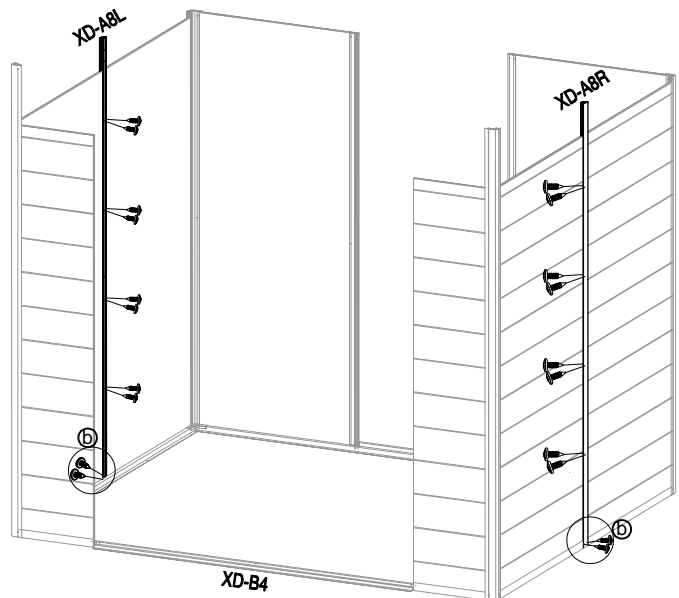
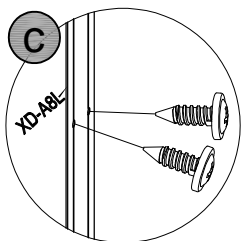
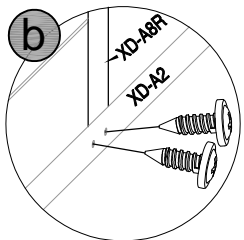
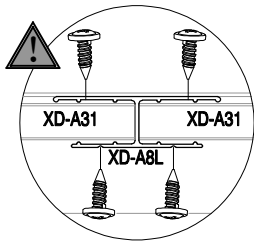
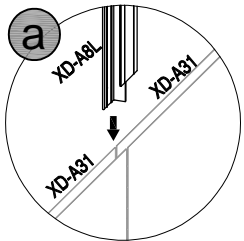

9							 CN-A33
	XD-A7 x2	XD-B30 x1					

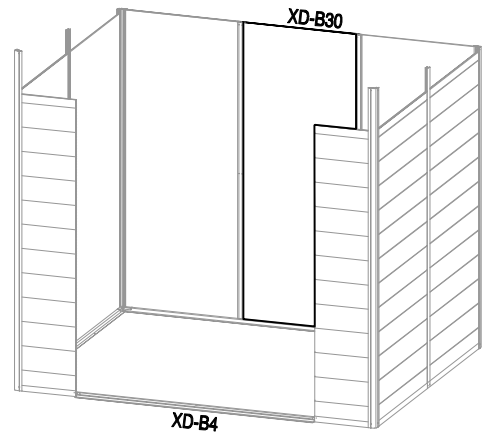
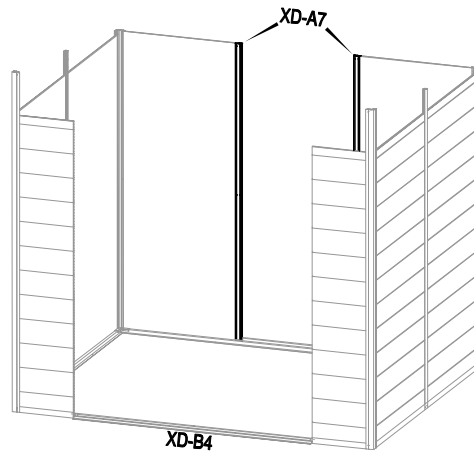
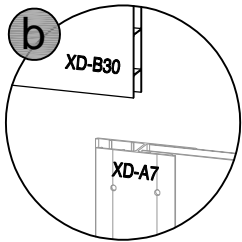
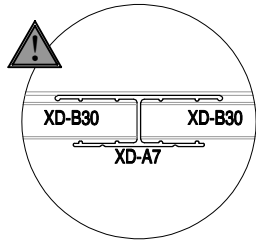
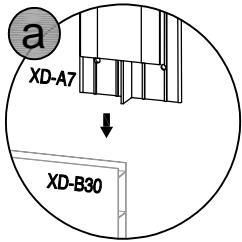

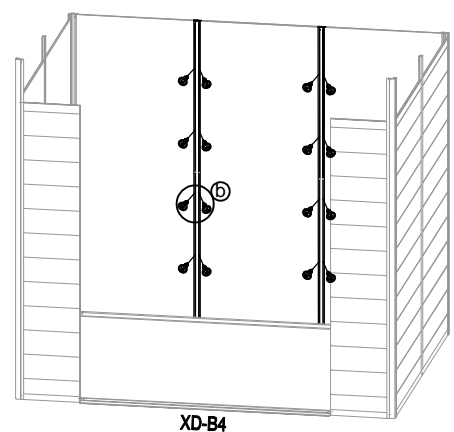
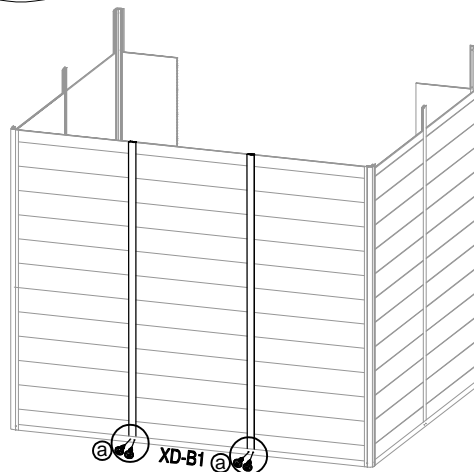
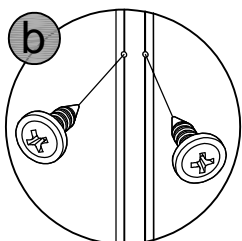
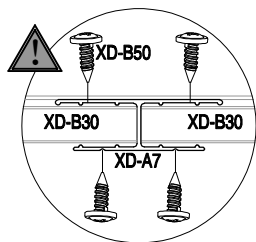
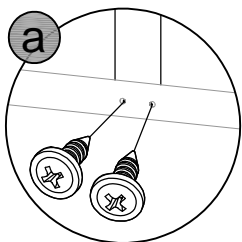

10							 CN-A33
	XD-B50 x20						

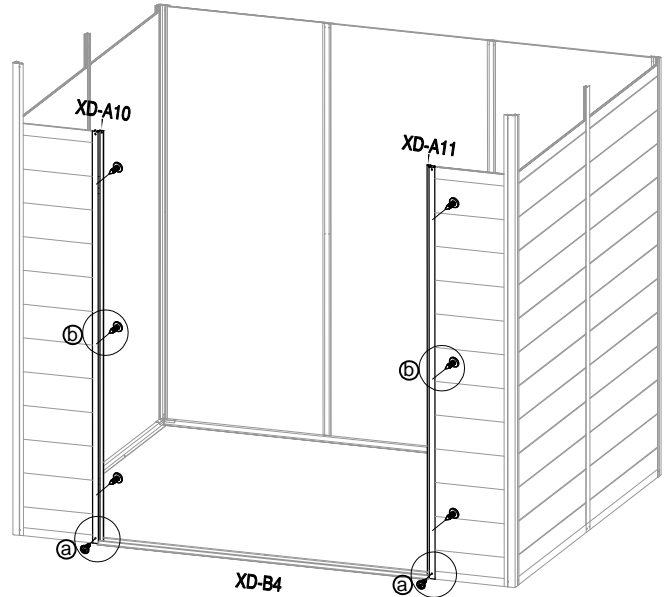
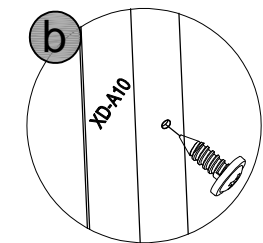
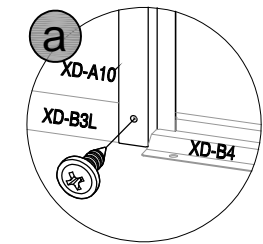
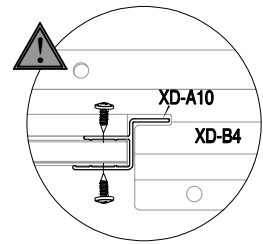

11	 XD-A10 x1	 XD-A11 x1	 XD-B50 x8				
----	--	--	--	--	--	--	--



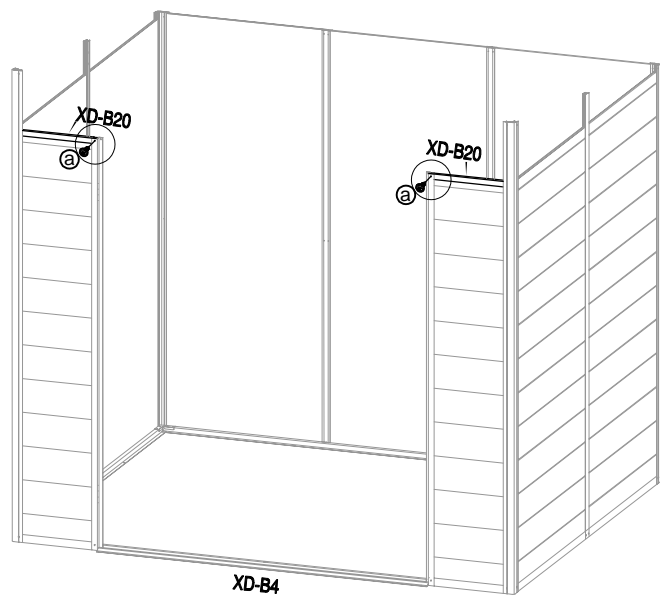
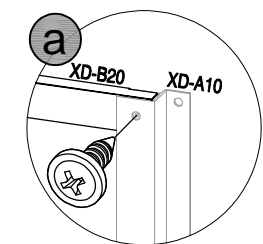

12	 XD-B20 x2	 XD-B50 x2					
----	--	--	--	--	--	--	--



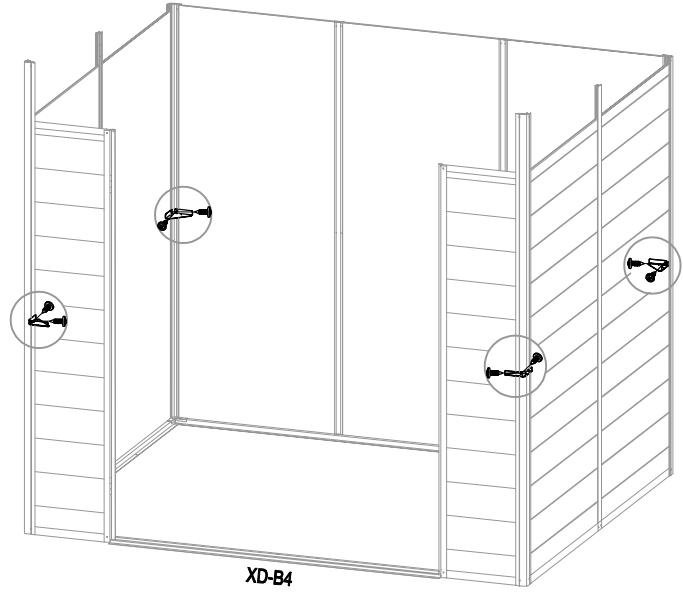
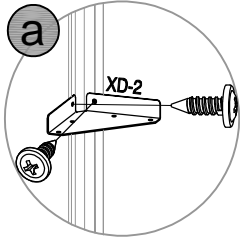



13	 XD-2 x4	 XD-B50 x8					
-----------	--	--	--	--	--	--	--

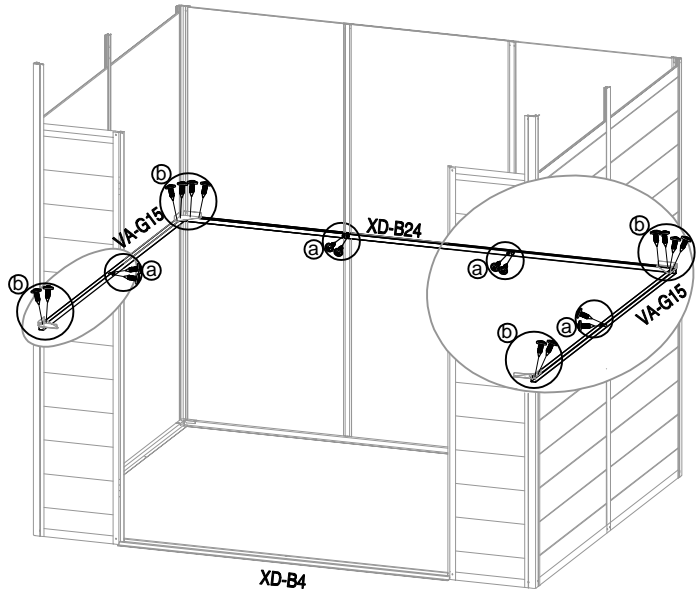
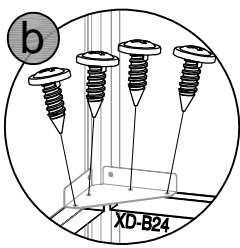
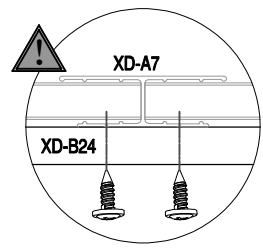
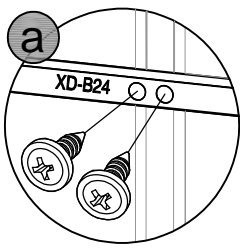

14	 XD-B24 x1	 VA-G15 x2	 XD-B50 x20				
-----------	--	--	---	--	--	--	--



15							
	VA-G14AL x1	VA-G14AR x1	VA-43 x2	XD-B50 x6			

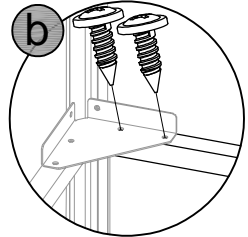
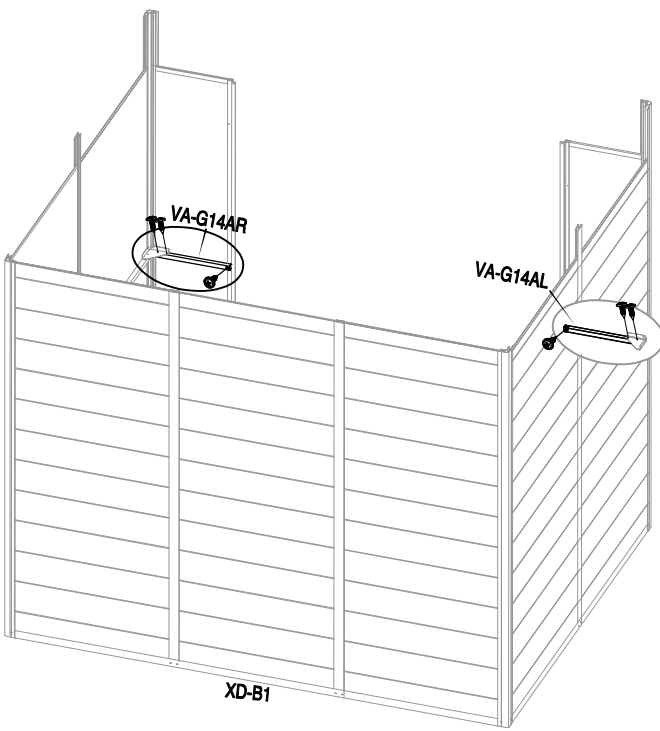
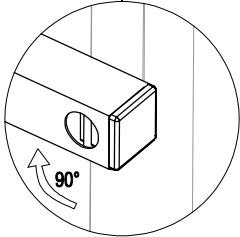
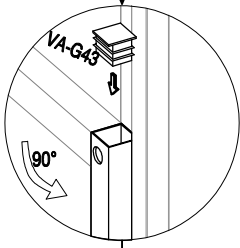
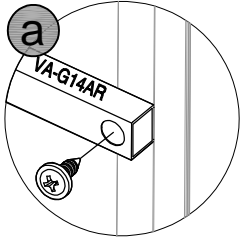

16							
	XD-B12 x1	XD-B50 x4	XD-B58 x2				

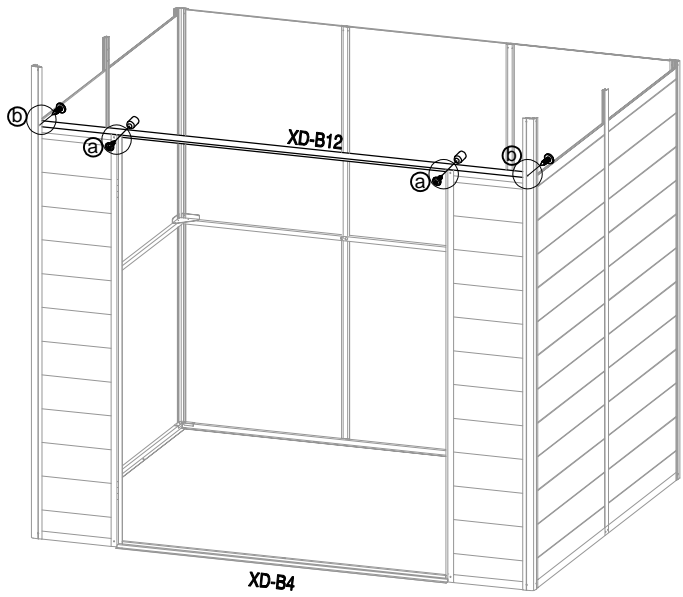
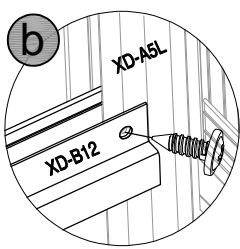
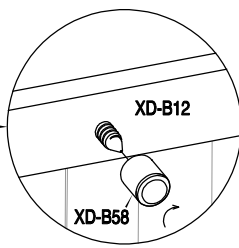
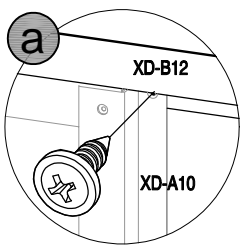
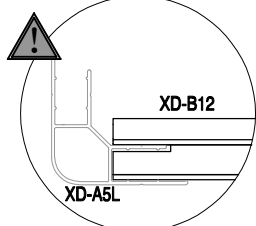

17							
	XD-B27 x1						

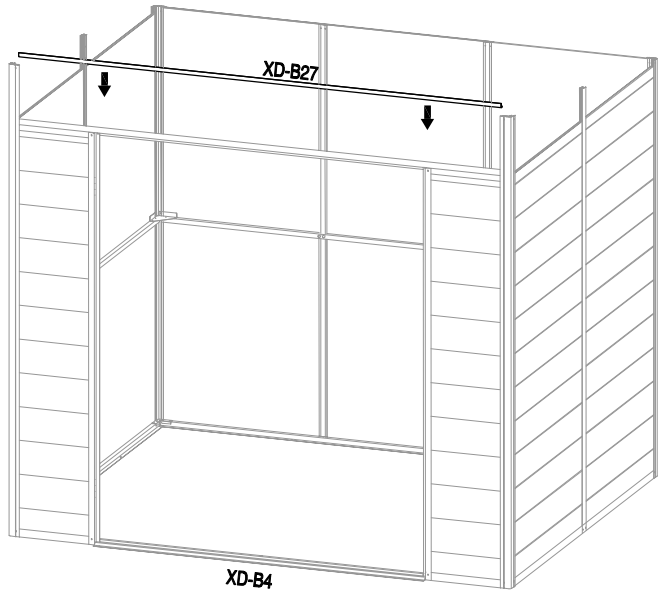
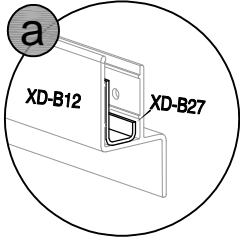



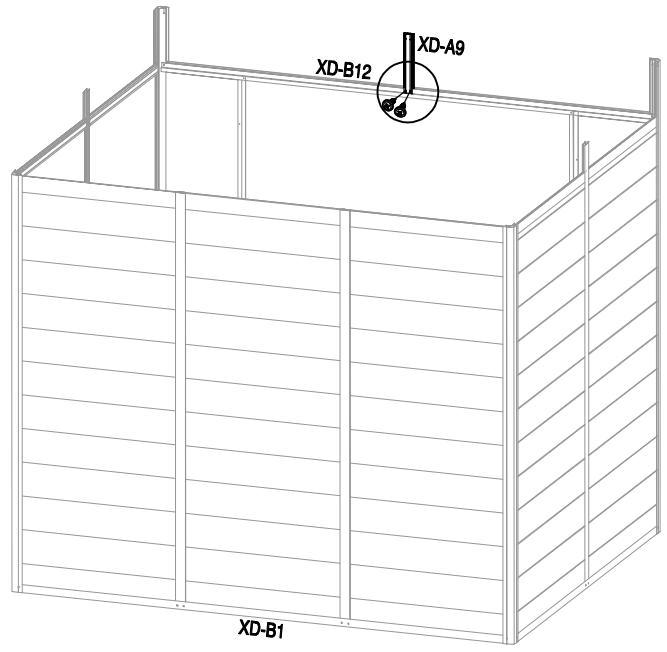
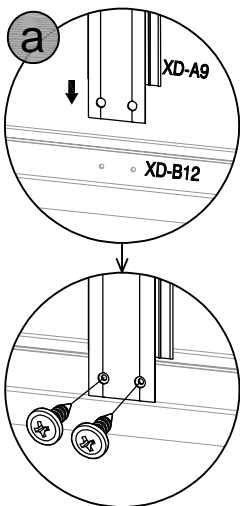

18							
	XD-A9 x1	XD-B50 x2					

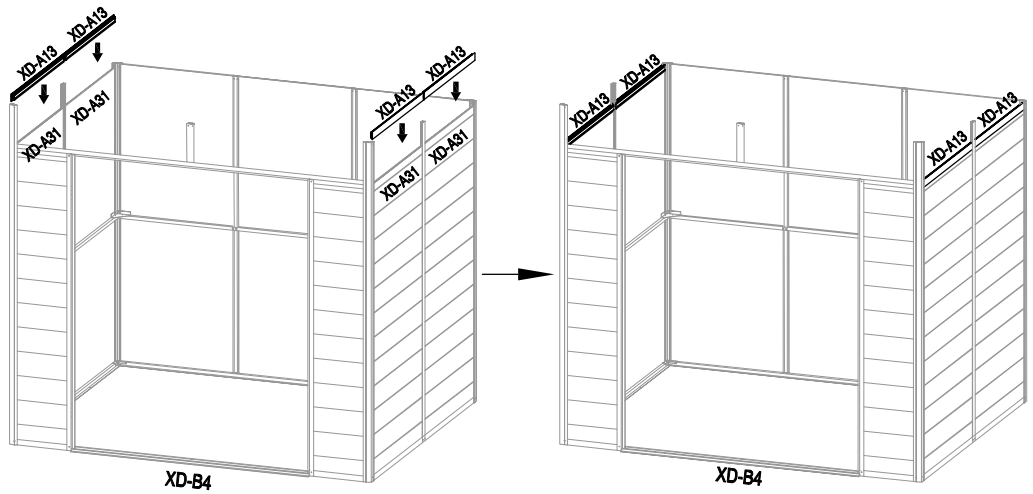
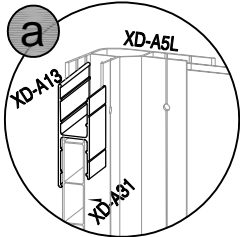
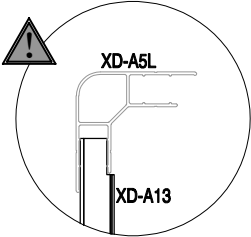

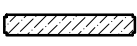
19							
	XD-A13 x4						





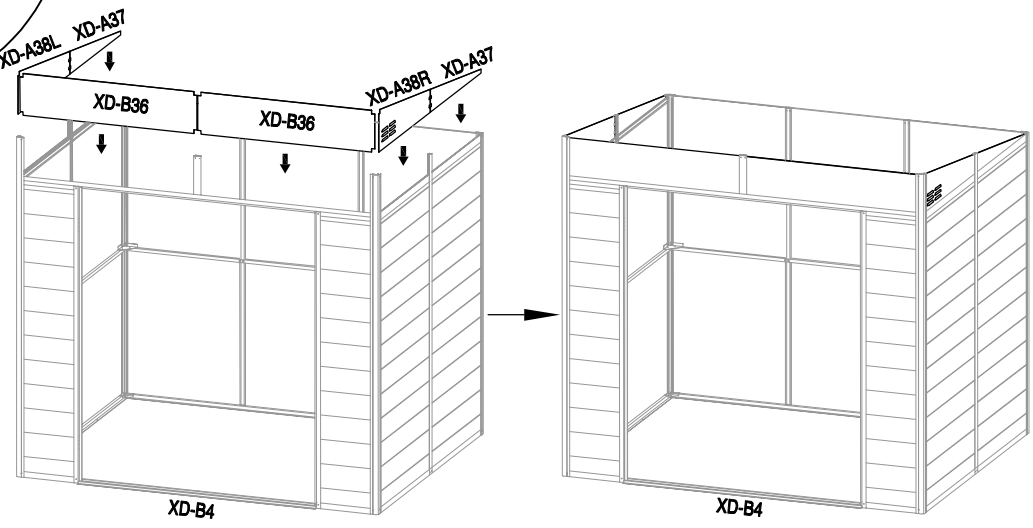
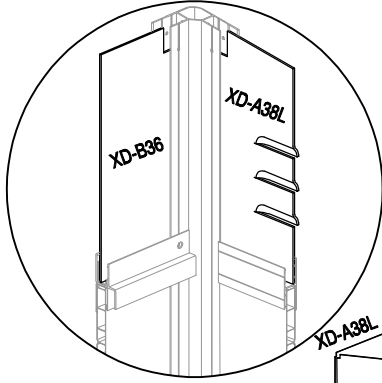

20							
	XD-B36 x2	XD-A37 x2	XD-A38L x1	XD-A38R x1			

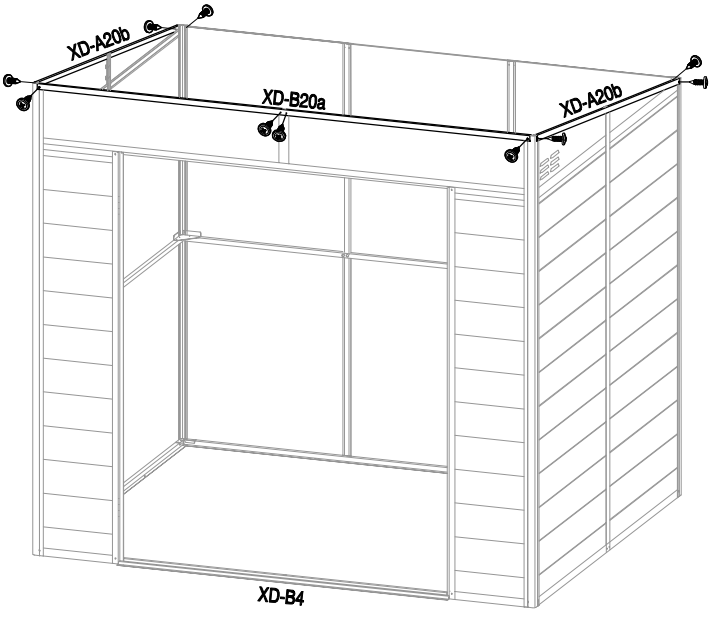
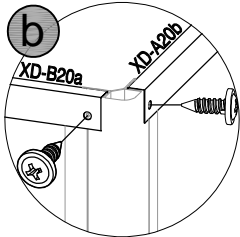
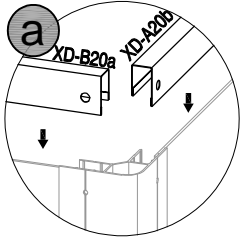





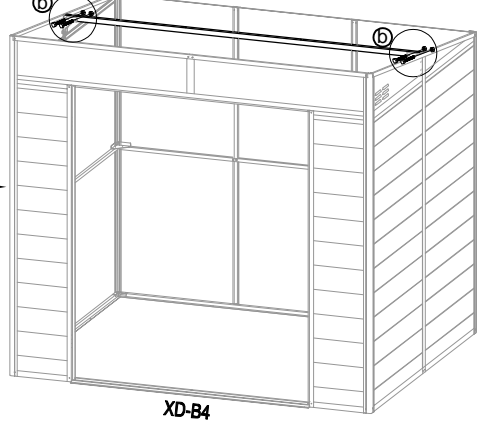
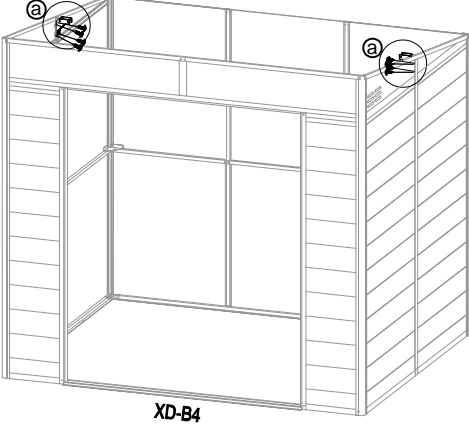
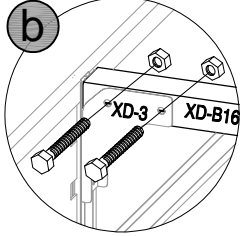
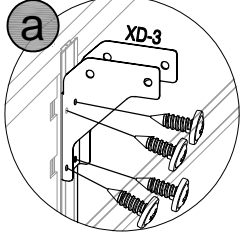

21	 XD-B20a x1	 XD-A20b x2	 XD-B50 x10				
-----------	---	---	---	--	--	--	--



22	 XD-3 x2	 XD-B16 x1	 XD-B50 x8	 XD-B56 x4			
-----------	--	--	--	--	--	--	--



23	 XD-B34a x1	 XD-B34b x2	 XD-A35 x2	 XD-B57 x2	 XD-B50 x24		 CN-A33
----	---	---	--	--	---	--	---

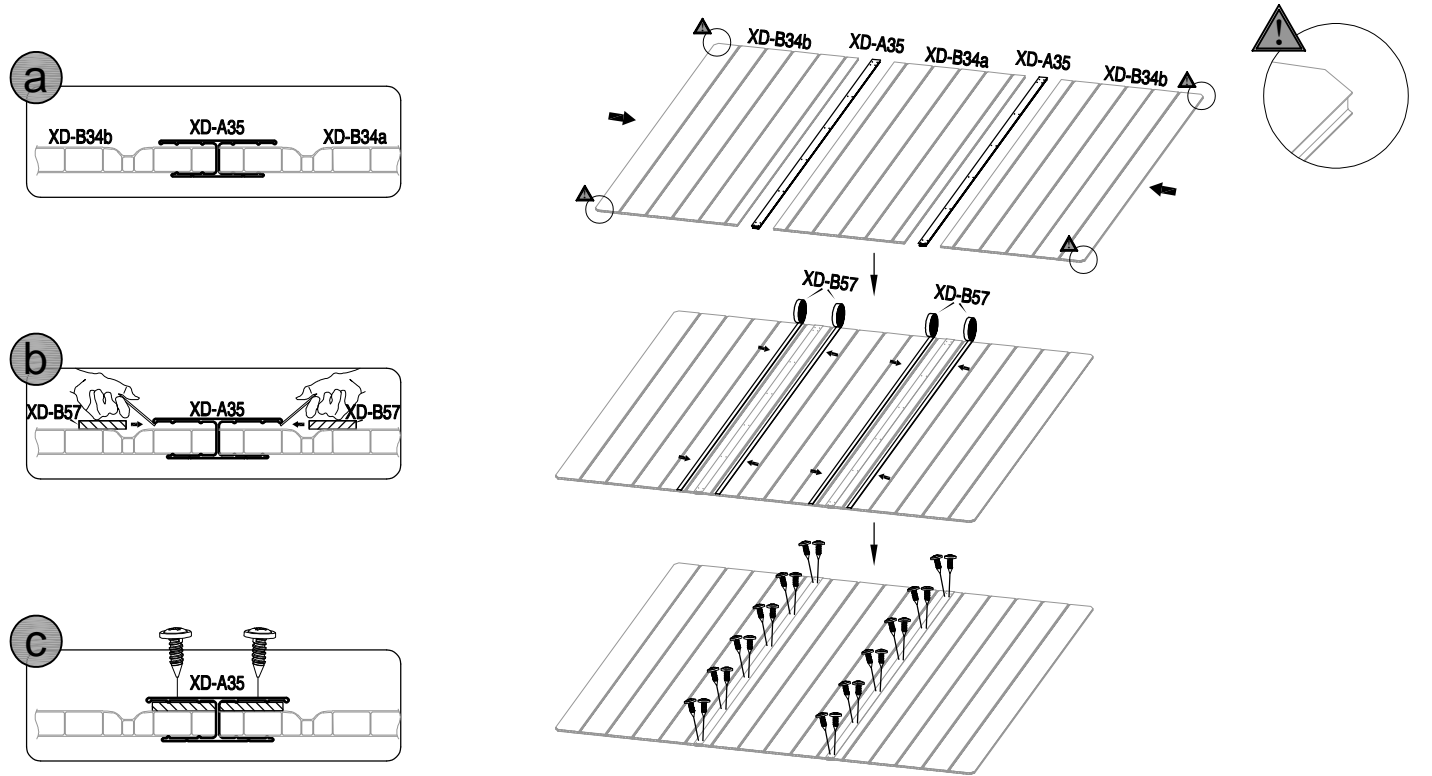

24	 XD-A18 x2						
----	--	--	--	--	--	--	--

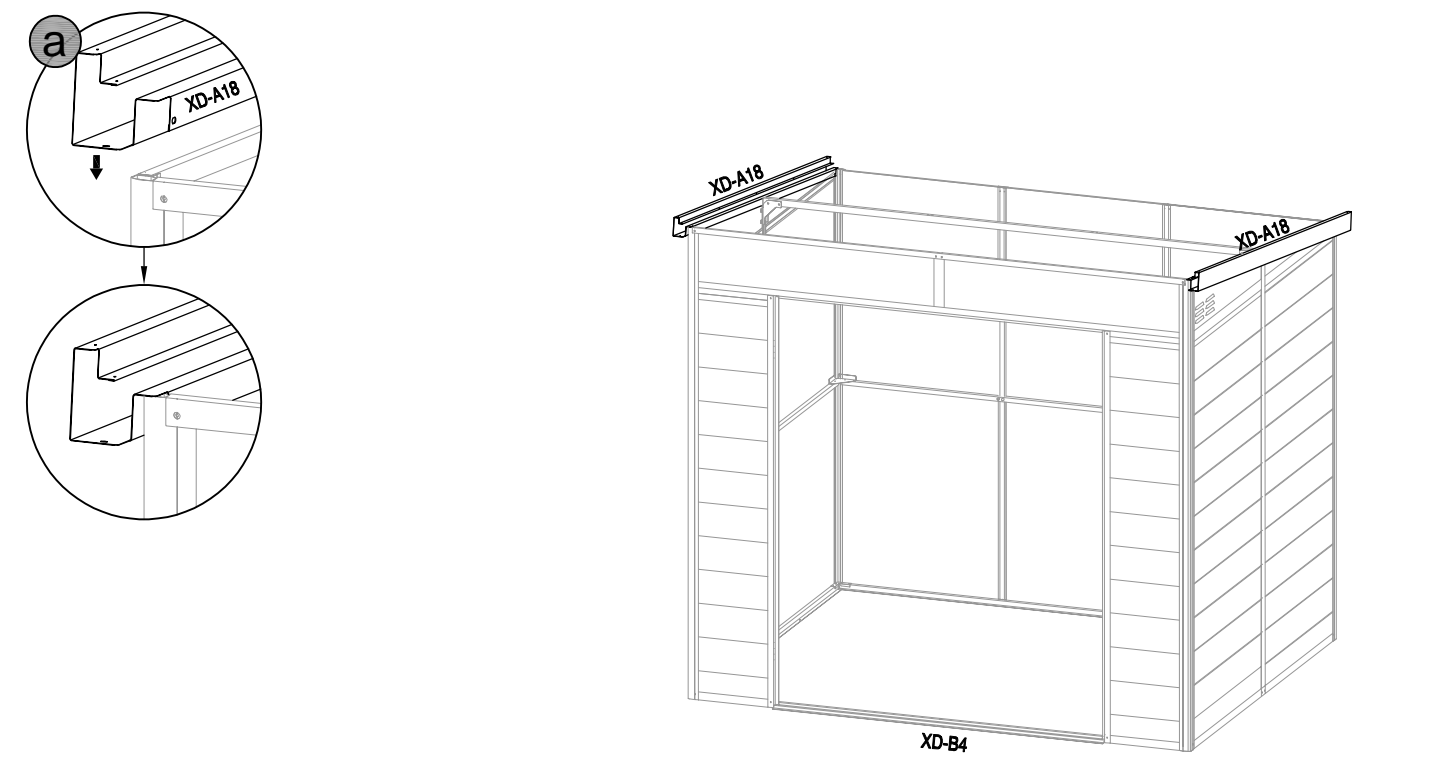

25	 XD-B17 x1	 M-23 x2					
----	--	--	--	--	--	--	--

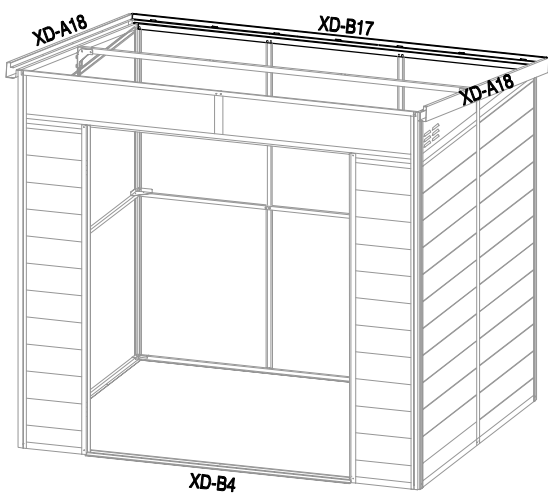
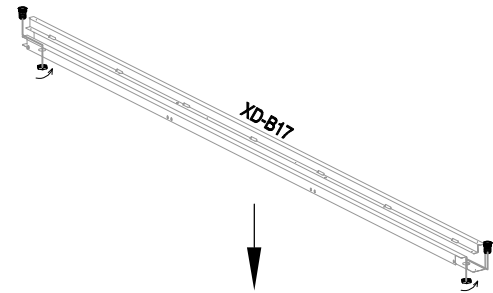
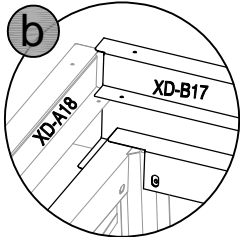
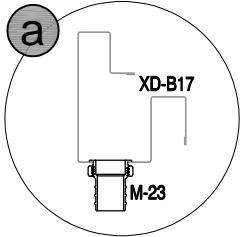

26							
----	--	--	--	--	--	--	--

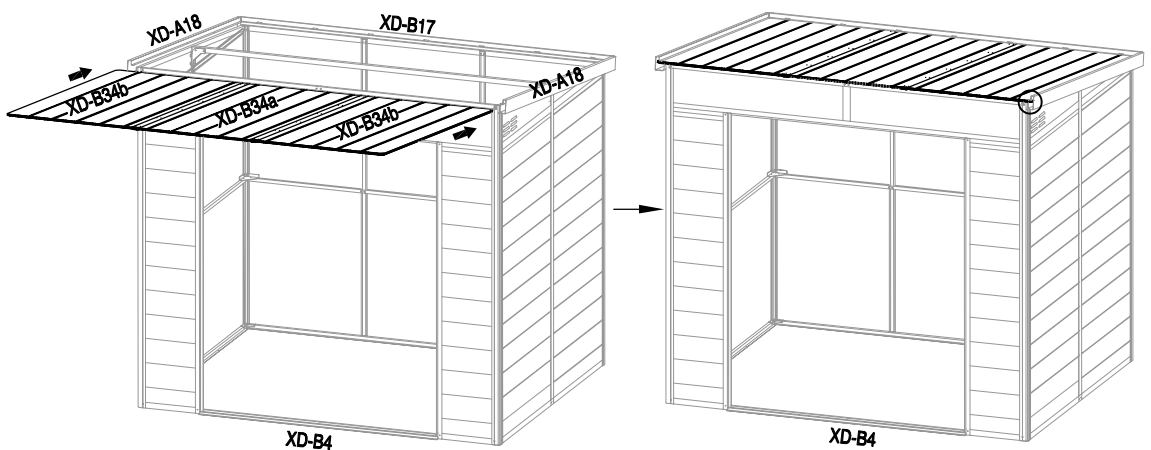
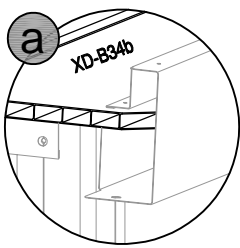
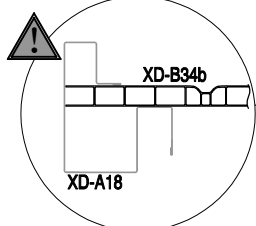

27	 XD-B19 x1	 XD-B50 x4					
----	--	--	--	--	--	--	--

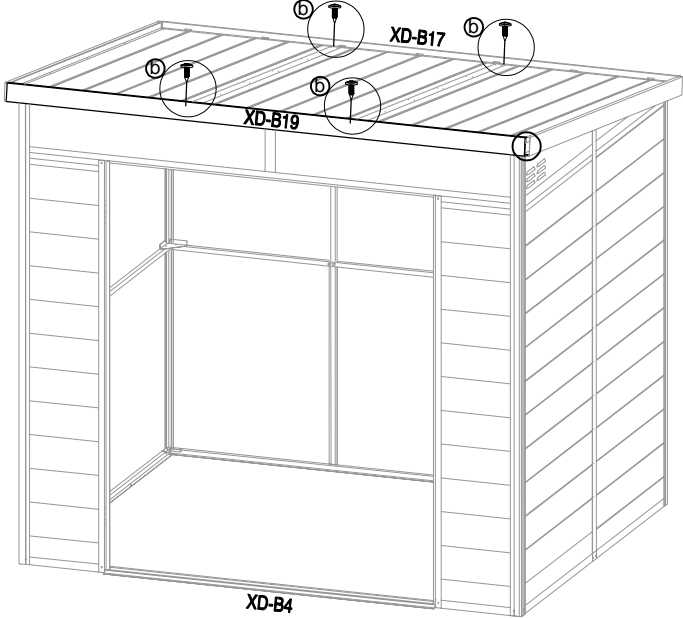
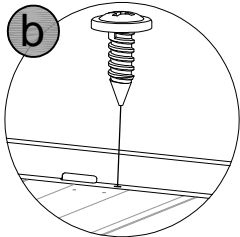
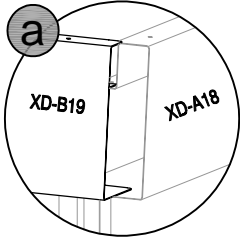

28	 XD-B50 x18						
----	---	--	--	--	--	--	--

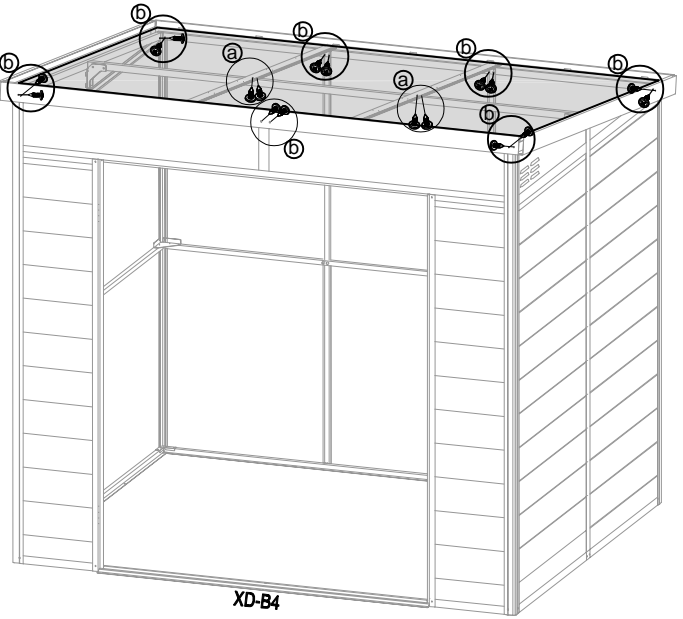
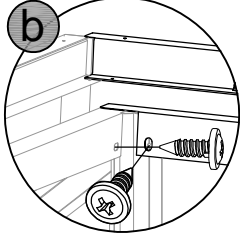
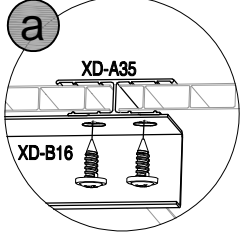



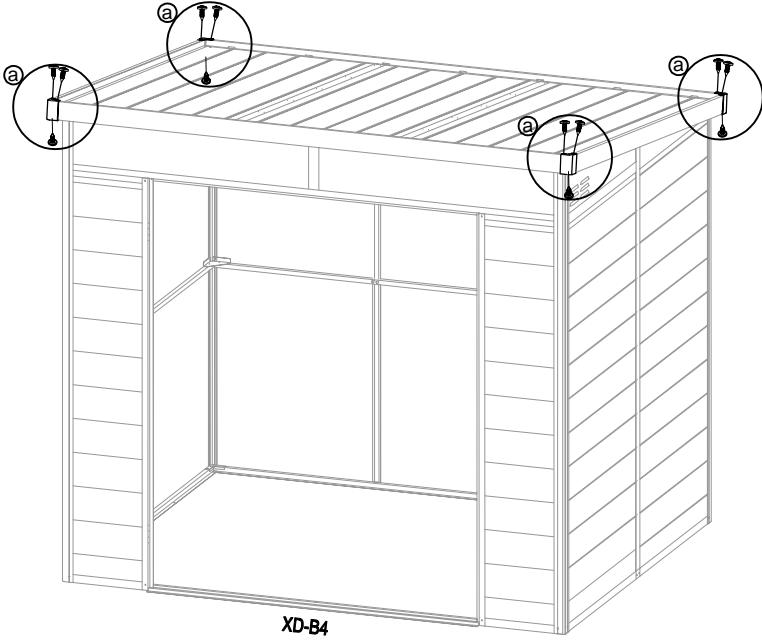
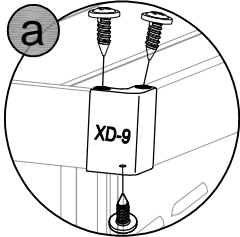

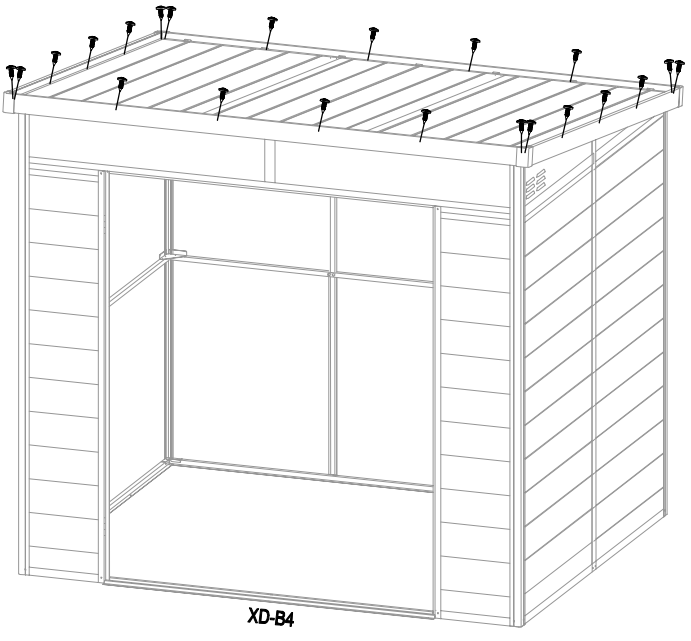
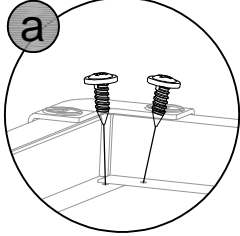
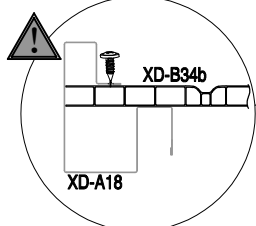

29	 XD-9 x4	 XD-B50 x12					
-----------	--	---	--	--	--	--	--



30	 XD-B50 x22						
-----------	---	--	--	--	--	--	--

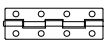



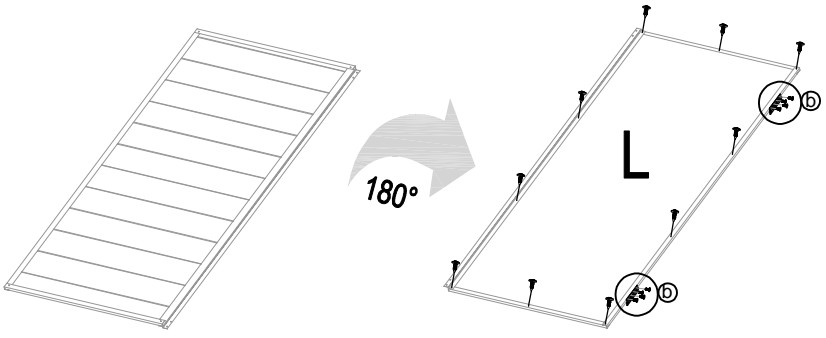
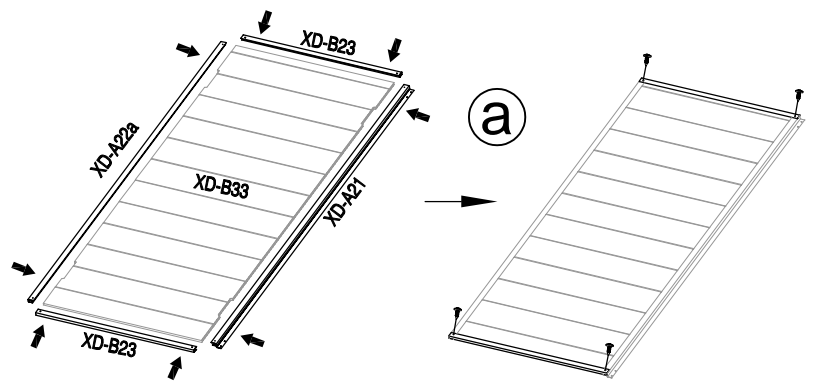
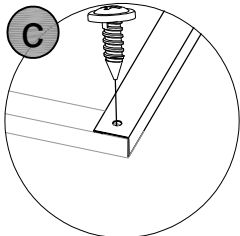
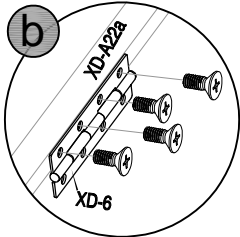
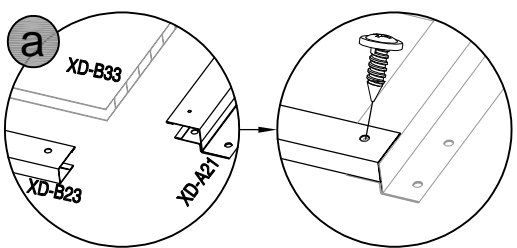

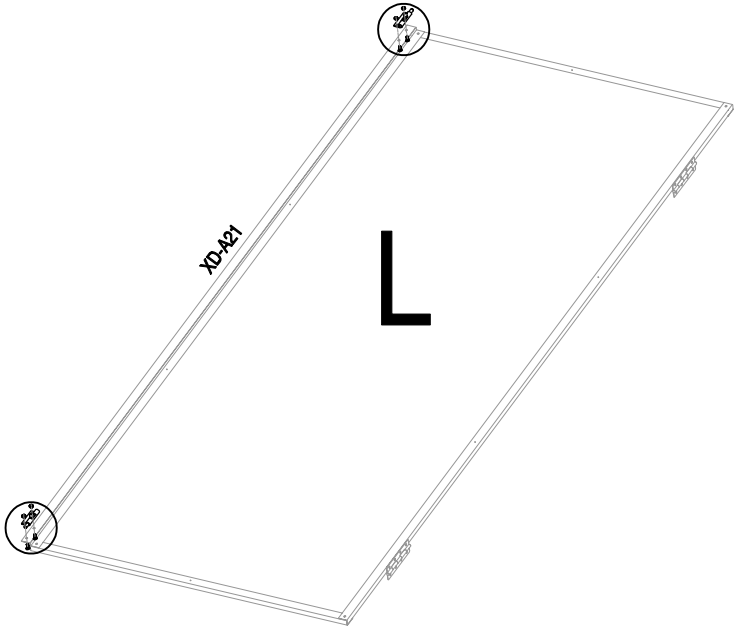
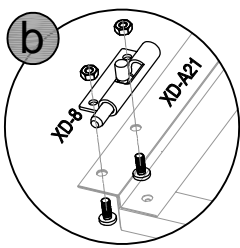
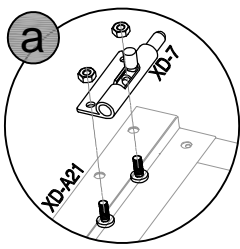

31	 XD-B33 x1	 XD-A21 x1	 XD-A22a x1	 XD-B23 x2	 XD-6 x2	 XD-B50 x14	 XD-B53 x8
----	--	--	---	--	---	---	--



32	 XD-7 x1	 XD-8 x1	 XD-B59 x4				
----	--	--	--	--	--	--	--

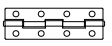



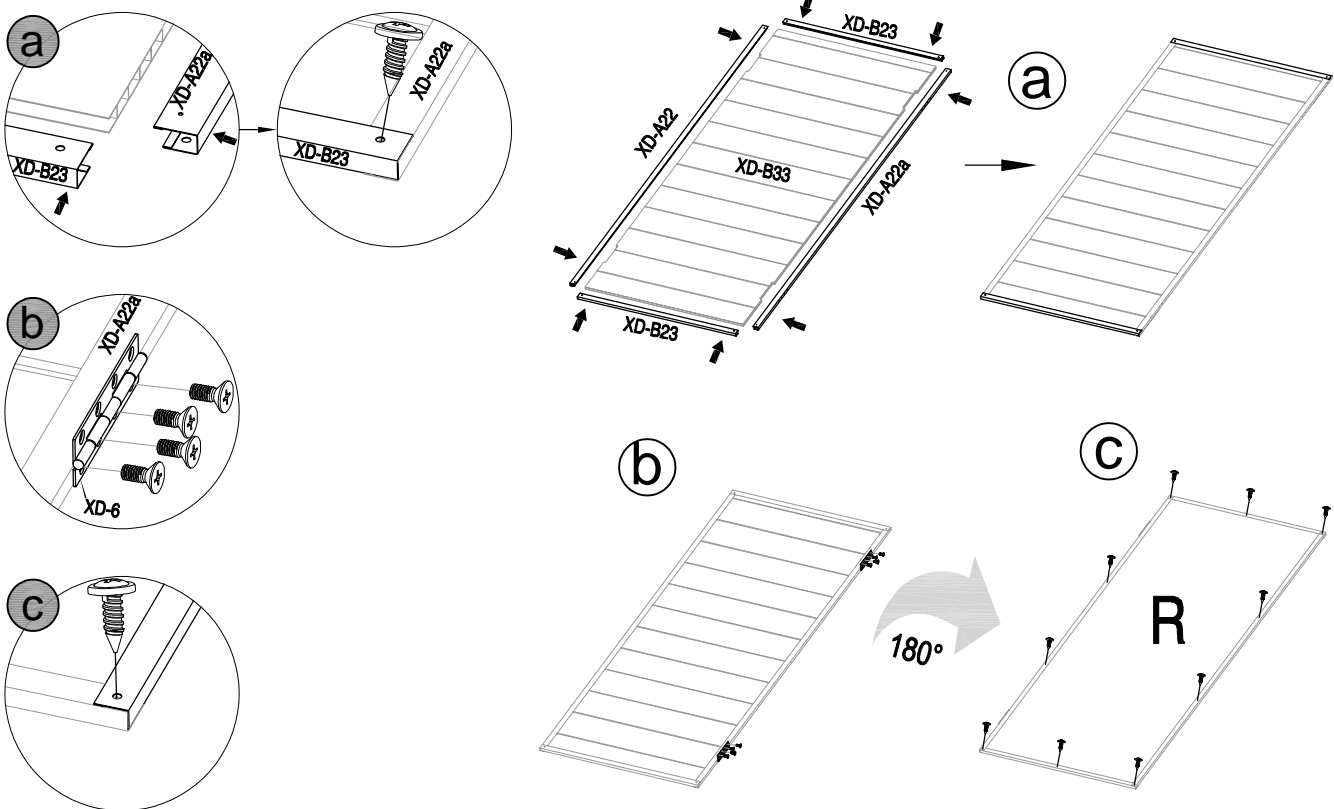

33	 XD-B33 x1	 XD-A22 x1	 XD-A22a x1	 XD-B23 x2	 XD-6 x2	 XD-B50 x14	 XD-B53 x8
----	--	--	---	--	---	---	--

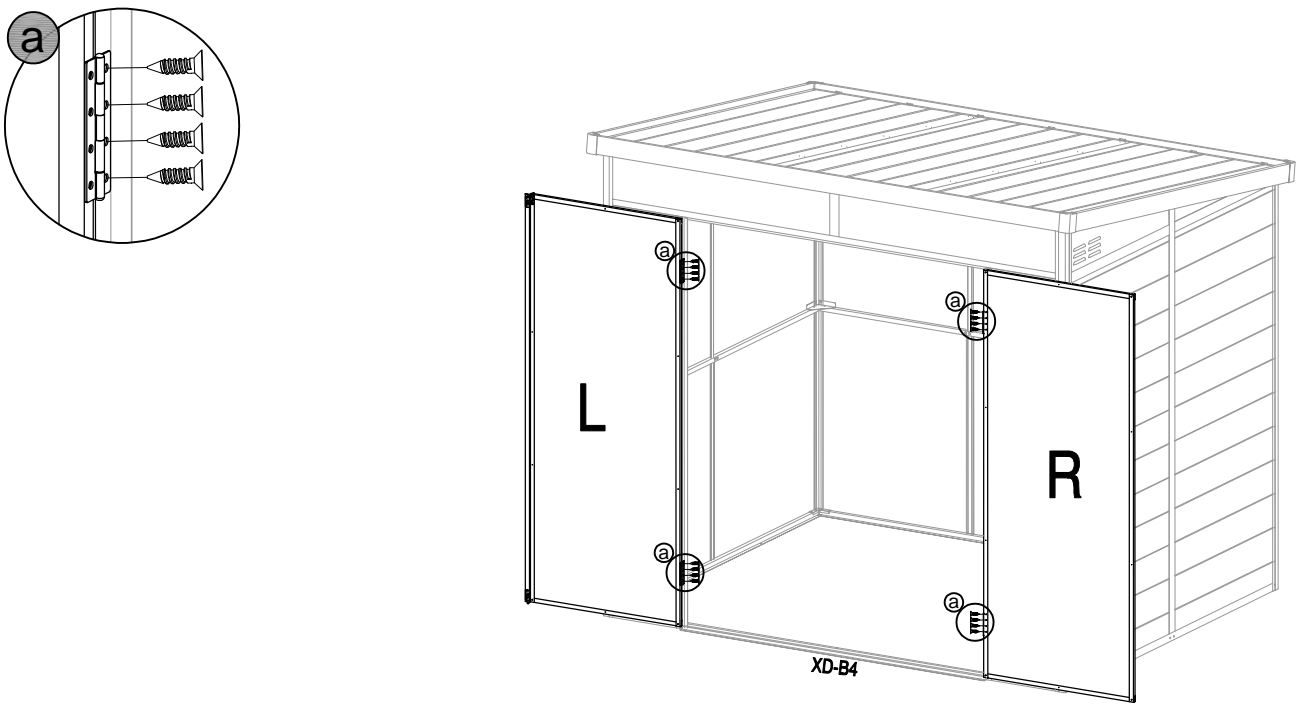

34	 XD-B54 x16						
----	---	--	--	--	--	--	--



35								
	XD-5 x1	PA01 x3	XD-B51 x3	XD-B52 x2				

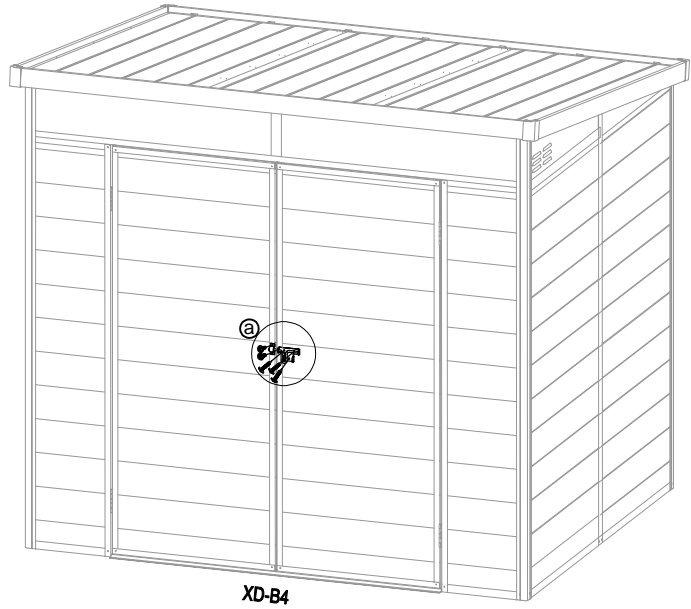
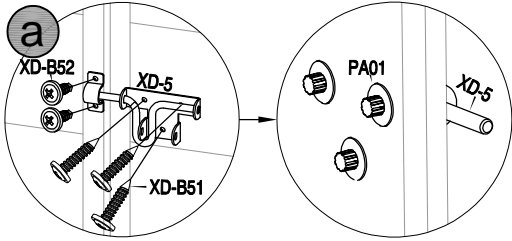
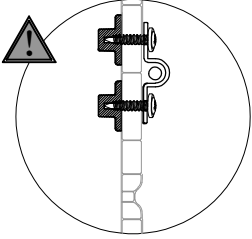

36								
	XD-10a x1							

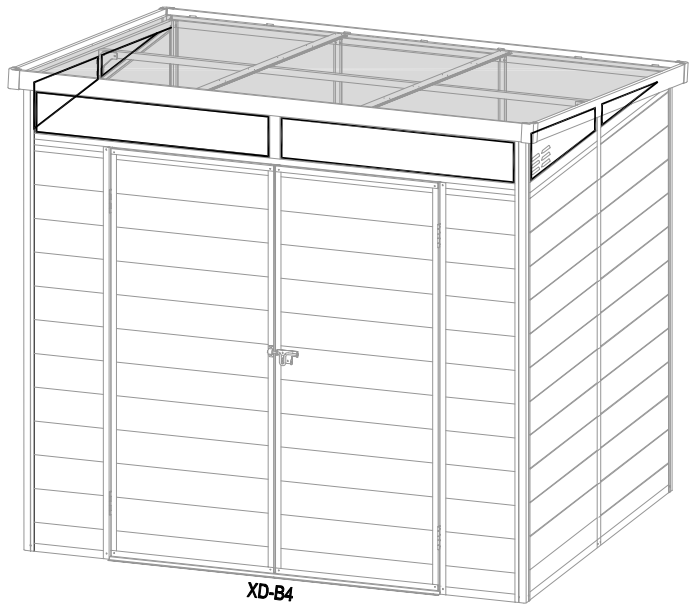
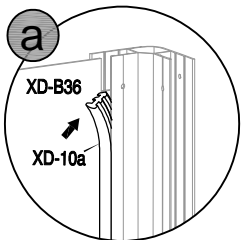
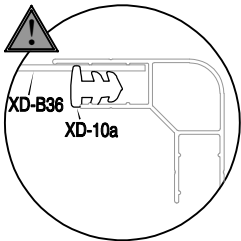

37



XD-B55 x12

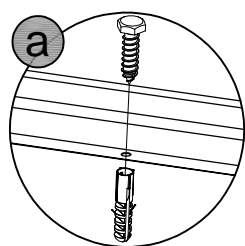
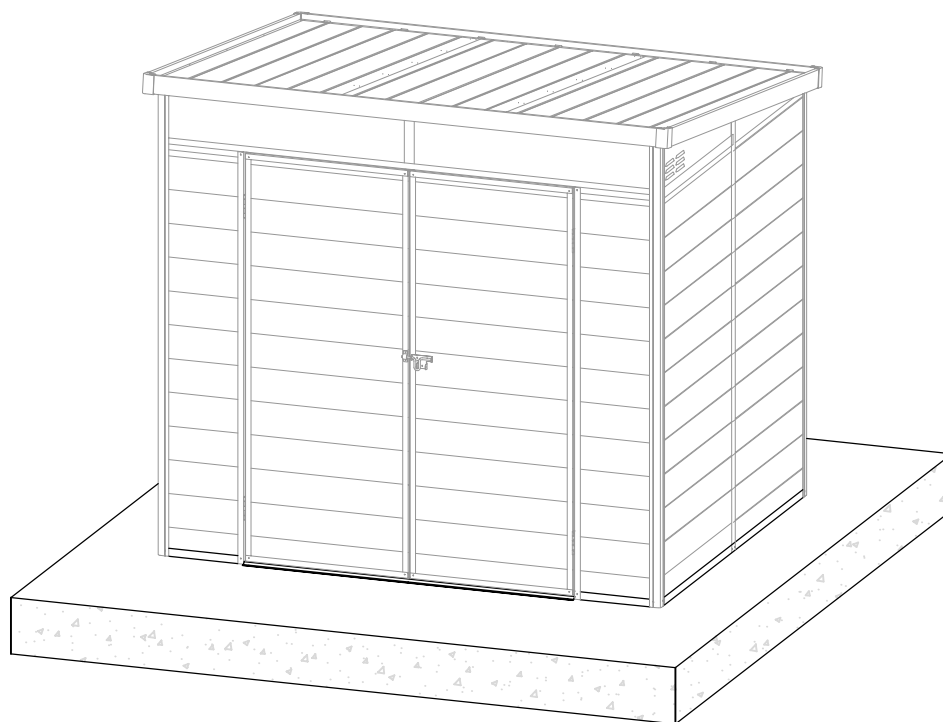

 A=B

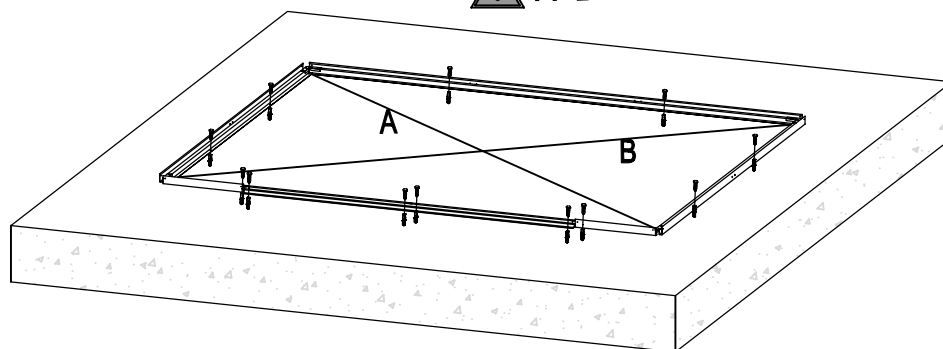

NÁVOD K MONTÁŽI A POUŽITÍ (CZ)

NÁVOD K POUŽITÍ. DŮLEŽITÉ! PROSÍME O POZORNÉ PŘEČTENÍ! DOPORUČUJEME USCHOVAT PRO POZDĚJŠÍ POUŽITÍ.

DŮLEŽITÁ UPOZORNĚNÍ! Výrobek slouží k domácímu použití. Čištění: vlažnou vodou s mýdlem a měkkým hadříkem. Veškeré díly produktu smontujte na plochem a rovném povrchu.

PŘED ZAHÁJENÍM MONTÁŽE

DŮLEŽITÁ UPOZORNĚNÍ! Přečtěte si všechny bezpečnostní pokyny v tomto návodu | Před zahájením montáže si přečtěte tento návod | Montáž veškerých dílů musí být provedena podle obrázkového návodu. Nevynechávejte žádnou z fází.

DÍLY

Veškeré díly vyjměte z obalu/obalů a rozložte na předem připravenou pracovní plochu. Způsob montáže (obrázky) je uveden v hlavním návodu.

DŮLEŽITÁ VAROVÁNÍ! Pokud dojde k poškození dílů špatnou montáží, nemůže se toto poškození brát jako reklamace. Je vyžadována montáž, demontáž a údržba produktu výhradně dospělou osobou. Před použitím vždy zkontrolujte bezpečnost, stabilitu výrobku a správnost jeho montáže. Nikdy nenechávejte děti bez dozoru, hrající si děti se musí vždy nacházet pod dohledem dospělé osoby.

Neponechávejte v blízkosti zdroje tepla, otevřeného ohně, klimatizačních jednotek. Vyhněte se drsným průmyslovým čističům, čističům na sklo a leštičům. Brusný nebo hrubý materiál může způsobit poškození povrchu.

Pravidelně kontrolujte také technický stav dílů, pokud bude některý z dílů poškozen nebo bude mít ostré hrany, nepoužívejte produkt, dokud neodstraníte závady nebo díly nevyměníte za nové. V případě otázek, zjištění absence nebo poškození dílu před montáží - produkt prosím nevracejte, pouze kontaktujte Vašeho prodejce.

Reklamační servis se vztahuje na výrobní vady, nikoli na mechanické poškození z důvodu užívání výrobku.

NÁVOD NA MONTÁŽ A POUŽITIE (SK)

NAVOD NA POUŽITIE. DOLEŽITE!

ČITAJTE POZORNE! ZACHOVAJTE PRE BUDUCE POUŽITIE. DŮLEŽITÉ UPOZORNENIE! Len pre domáce použitie.

Čistenie: vlažnou vodou s mydlom a mäkkou handričkou. Všetky prvky výrobku by mali byť montované na rovnej ploche.

PRED ZAČATÍM MONTÁŽE

DŮLEŽITÉ UPOZORNENIE! Pozrite sa prosím na pokyny k bezpečnosti v tomto návodu | Pred montážou oboznámte sa s návodom | Montáž všetkých komponentov by mala byť vykonaná v súlade s obrázkovým návodom. | Nevynechávajte žiadne kroky.

ČASTI

Všetky prvky musia byť vybraté z obalu (-ov) a zložené na vopred pripravenej pracovnej ploche. Spôsob montáže (obrázky) je uvedený v hlavnom návode.

DŮLEŽITÉ UPOZORNENIE! Pokiaľ dôjde k poškodeniu dielov zlou montážou, nemôže sa toto poškodenie brať ako reklamácia. Montáž, demontáž a údržbu výrobku môže vykonávať iba dospelá osoba. Pred použitím vždy skontrolujte bezpečnosť, stabilitu výrobku a správnosť jeho inštalácie. Nikdy nenechávajte dieťa bez dozoru, hrajúce sa deti vždy vyžadujú dohľad dospeléj osoby. Nenechávajte zdroj tepla, otvorený oheň, klimatizačné jednotky. Vyvarujte sa drsným priemyselným čistiacim prostriedkom, čistiacim prostriedkom na sklenené a leštičkami. Brušný alebo hrubý materiál môže spôsobiť poškodenie povrchu.

Skontrolujte tiež technický stav častí, ak je jedna z častí poškodená alebo má ostré hrany, nepoužívajte produkt, kým neodstránite chyby alebo diely s novými. V prípade otázok, nájdenie neprítomnosti alebo poškodenia dielu pred montážou - nevráťte produkt, stačí sa obrátiť na svojho predajcu.

Služba sa vzťahuje na výrobné chyby, nie mechanické poškodenie v dôsledku použitia produktu.

INSTRUCTIONS FOR ASSEMBLY AND USE (EN)

INSTRUCTIONS FOR USE. IMPORTANT! PLEASE READ CAREFULLY! RECOMMEND SAVE FOR FUTURE USE.

IMPORTANT NOTICE! The product is for home use. Cleaning: lukewarm water with soap and a soft cloth. Assemble all parts of the product on a flat and level surface.

BEFORE STARTING ASSEMBLY

IMPORTANT NOTICE! Read all safety instructions in this manual | Read this manual before starting the assembly | The assembly of all parts must be carried out according to the pictorial instructions. Don't miss any of the stages.

PARTS

Remove all parts from the package(s) and lay them out on a pre-prepared work surface. The method of assembly (pictures) is given in the main instructions.

IMPORTANT WARNINGS! If parts are damaged due to improper assembly, this damage cannot be taken as complaint. Assembly, disassembly and maintenance of the product is required only by an adult. Before use, always check the safety, stability of the product and the correctness of its assembly. Never leave children unattended, children playing must always be supervised by an adult.

Do not leave near heat sources, open flames, air conditioning units. Avoid harsh industrial cleaners, glass cleaners and polishes. Abrasive or rough material can damage the surface.

Also check the technical condition of the parts regularly, if any of the parts are damaged or have sharp edges, do not use the product until the defects are eliminated or the parts are replaced with new ones. In case of questions, detection of absence or damage of a part before assembly - please do not return the product, just contact your dealer.

The complaint service applies to manufacturing defects, not to mechanical damage due to the use of the product.

MONTAGE- UND GEBRAUCHSANLEITUNG (DE)

GEBRAUCHSANWEISUNG. WICHTIG! BITTE AUFMERKSAM LESEN! EMPFEHLEN, FÜR ZUKÜNFTIGE VERWENDUNG ZU SPEICHERN.

WICHTIGER HINWEIS! Das Produkt ist für den Hausgebrauch bestimmt. Reinigung: lauwarmes Wasser mit Seife und einem weichen Tuch.

Montieren Sie alle Teile des Produkts auf einer flachen und ebenen Oberfläche.

BEVOR SIE MIT DER MONTAGE BEGINNEN

WICHTIGER HINWEIS! Lesen Sie alle Sicherheitshinweise in diesem Handbuch | Lesen Sie diese Anleitung, bevor Sie mit der Montage beginnen | Der Zusammenbau aller Teile muss gemäß der bebilderten Anleitung erfolgen. Verpassen Sie keine Etappe.

TEILE

Entnehmen Sie alle Teile aus der/den Verpackung(en) und legen Sie diese auf einer vorbereiteten Arbeitsfläche aus. Die Montagemethode (Bilder) ist in der Hauptanleitung angegeben.

WICHTIGE WARNHINWEISE! Werden Teile durch unsachgemäße Montage beschädigt, kann dieser Schaden nicht anerkannt werden. Die Montage, Demontage und Wartung des Produkts ist nur durch einen Erwachsenen erforderlich. Überprüfen Sie vor dem Gebrauch immer die Sicherheit, Stabilität des Produkts und die Korrektheit seiner Montage. Lassen Sie Kinder niemals unbeaufsichtigt, spielende Kinder müssen immer von einem Erwachsenen beaufsichtigt werden.

Nicht in der Nähe von Wärmequellen, offenen Flammen oder Klimaanlage aufbewahren. Vermeiden Sie scharfe Industriereiniger, Glasreiniger und Polituren. Abrasives oder raues Material kann die Oberfläche beschädigen.

Überprüfen Sie auch regelmäßig den technischen Zustand der Teile, falls Teile beschädigt oder scharfkantig sind, verwenden Sie das Produkt nicht, bis die Mängel behoben sind oder die Teile durch neue ersetzt wurden. Bei Fragen, Fehlen oder Beschädigung eines Teils vor dem Zusammenbau - bitte senden Sie das Produkt nicht zurück, sondern wenden Sie sich an Ihren Händler.

Der Reklamationservice gilt für Herstellungsfehler, nicht für mechanische Schäden aufgrund der Verwendung des Produkts.

INSTRUKCJA MONTAŻU I UŻYTKOWANIA (PL)

INSTRUKCJA UŻYTKOWANIA. WAŻNE! PROSIMY UWAŻNIE PRZECZYTAĆ! PROPONUJEMY ZACHOWAĆ DO POŹNIEJSZEGO STOSOWANIA.

WAŻNE OSTRZEŻENIA! Wyłącznie do użytku domowego. Czyszczenie: letnią wodą z dodatkiem detergentu i miękką szmatką. Wszystkie elementy produktu należy montować na płaskiej powierzchni.

PRZED ROZPOCZĘCIEM MONTAŻU

WAŻNE OSTRZEŻENIA! Przeczytaj wszystkie instrukcje dotyczące bezpieczeństwa zawarte w tej instrukcji. | Przed przystąpieniem do montażu należy zapoznać się z instrukcją |

Montaż wszystkich elementów powinien być wykonany zgodnie z instrukcją | Nie należy pomijać żadnego z etapów |

CZĘŚCI

Wszystkie elementy należy wyciągnąć z opakowania (-ań) i rozłożyć na uprzednio przygotowanej do pracy powierzchni. Sposób montażu (rysunki) znajduje się w głównej Instrukcji.

WAŻNE OSTRZEŻENIA! Jeśli części zostaną uszkodzone przez niewłaściwy montaż, takie uszkodzenie nie może być uznane za roszczenie. Wymagany jest montaż, demontaż oraz konserwacja produktu wyłącznie przez osobę dorosłą. Przed użyciem zawsze sprawdzam bezpieczeństwo, stabilność produktu i poprawność jego montażu. Nigdy nie pozostawiaj dziecka bez opieki, bawiące się dzieci zawsze wymagają nadzoru osoby dorosłej.

Nie pozostawiać w pobliżu źródeł ciepła, otwartego ognia, urządzeń klimatyzacyjnych. Unikaj ostrych przemysłowych środków czyszczących, środków do czyszczenia szkła i past. Materiały ściernie lub szorstkie mogą uszkodzić powierzchnię.

Regularnie sprawdzaj również stan techniczny części, jeśli któraś z części jest uszkodzona lub ma ostre krawędzie, nie używaj produktu do czasu usunięcia wad lub wymiany części na nowe. W przypadku pytań, wykrycia braku lub uszkodzenia części przed montażem - prosimy nie odsyłać produktu, tylko skontaktować się ze sprzedawcą.

Usługa reklamacji dotyczy wad fabrycznych, a nie uszkodzeń mechanicznych powstałych w wyniku użytkowania produktu.

ÖSSZESZERELÉSI ÉS HASZNÁLATI ÚTMUTATÓ (HU)

HASZNÁLATI ÚTMUTATÓ. FONTOS! KERJUK FIGYELMESEN ELOLVASNI! KERJUK MEGŐRIZNI KESŐBBI

FELHASZNÁLÁS CELJÁBOL. FONTOS FIGYELMEZTETÉSEK! Kizárólag otthoni használatra. Tisztítás: langyos mosószeres vízzel és puha törülközővel. A termékelemeit lapos felületen kell összeszerelni.

AZ ÖSSZESZERELÉS MEGKEZDÉSE ELŐTT

FONTOS FIGYELMEZTETÉSEK! Olvasson el minden biztonsági előírást ebben a kézikönyvben. | Az összeszerelés megkezdése előtt ismerkedjen meg az útmutatóval | Az elemek összeszerelését az útmutatónak meg felelően kell végrehajtani | Az összeszerelés egyik szakaszát sem szabad kihagyni.

RÉSZEI

Az összes elemet ki kell venni a csomagolás(ok) ből és lehelyezni egy előzőleg kialakított felületre. Összeszerelési útmutatója (ábrák) a főútmutatóban található.

FONTOS FIGYELMEZTETÉSEK! Ha az alkatrészek nem megfelelő összeszerelés miatt megsérülnek, az ilyen károk nem tekinthetők követelésnek. A termék összeszerelését, szétszerelését és karbantartását kizárólag felnőtt személy végezheti. Használat előtt mindig ellenőrizd a termék biztonságos használatát, stabilitását és az összeszerelés helyességét. A

Gyermekeket sohasem szabad felügyelet nélkül hagyni, a játékos gyermekek minden esetben felnőtt felügyeletét igénylik.

Ne hagyja el a hőforrást, nyitja meg a tüzet, a légkondicionáló egységeket. Kerülje a kemény ipari tisztítószereket, az üvegtisztítókat és a polírozókat. A csiszoló vagy durva anyag a felület károsodását okozhatja.

Ellenőrizze az alkatrészek műszaki állapotát is, ha az alkatrészek egyike megsérült vagy éles széle van, ne használja a terméket, amíg eltávolítja a hibákat vagy az új részeket. Kérdések esetén az alkatrész hiányának vagy károsodásának megtalálása az összeszerelés előtt - kérjük, ne adja vissza a terméket, csak vegye fel a kapcsolatot a kereskedővel.

A panaszszolgálat a termelési hibákra vonatkozik, nem pedig a termék használatának oka mechanikai károkra.

NAVODILA ZA MONTAŽO IN UPORABO (SLO)

NAVODILO ZA UPORABO. POMEMBNO. PROSIMO PREBRATI PREVIDNO. SHRANITE ZA

UPORABO V PRIHODNOSTI. POMEMBNA OPOZORILA! Samo za hišnouporabo. Čiščenje z mlako vodo z detergentom in mehkomkropom. Vse elemente izdelkamontirajte na ravnipovršini.

PRED MONTAŽO

POMEMBNA OPOZORILA! Preberite vsa varnostna navodila v tem priročniku | Predmontaž opreberite navodila | Vse elemente je treba montirati skladno z navodili | Ne spregledajte nobenega koraka.

ELEMENTI

Vse elemente potegniti iz embalaže (embalaž) ter jih položite na prej pripravljene delovni površini.

Način montaže (risbe) se nahaja v glavnih navodilih.

POMEMBNA OPOZORILA! Če se deli poškodujejo zaradi nepravilne montaže, takšne škode ni mogoče šteti za reklamacijo. Izdelek lahko montira, demontirati vzdržuje izključno odrasla oseba.

Ne puščajte v bližini virov toplote, odprtega ognja, klimatskih naprav. Izogibajte se močnim industrijskim čistilom, čistilom za steklo in loščilom. Abrazivni ali grobi materiali lahko poškodujejo površino.

Prav tako redno preverjajte tehnično stanje delov, če je kateri od delov poškodovan ali ima ostre robove, izdelka ne uporabljajte, dokler napake niso odpravljene ali deli niso zamenjani z novimi. V primeru vprašanj, odkritja odsotnosti ali poškodbe dela pred montažo - izdelka ne vračajte, temveč se obrnite na svojega prodajalca.

Reklamacijski servis velja za napake v izdelavi, ne za mehanske poškodbe zaradi uporabe izdelka.

INSTRUCȚIUNI DE MONTAJ ȘI UTILIZARE (RO)

INSTRUCȚIUNI DE UTILIZARE. VA RUGAM CITITI CU ATENTIE. PATRATI PENTRU FOLOSIREA ULTERIOARA. AVERTISMENTE IMPORTANTE!

Numai pentru uz casnic. Curățarea: cuapăcălduță cu detergent și panza moale. Toate piesele din produs trebuie montate pe o suprafață plată.

ÎNAINTE DE ÎNCEPEREA MONTAJULUI

AVERTISMENTE IMPORTANTE! Citiți toate instrucțiunile de siguranță din acest manual | Înainte de a începe montajul citiți instrucțiunile |

Montaj tuturor pieselor trebuie realizat în conformitate cu instrucțiunile | Nu omiteți nicio etapă.

PIESELE

Toate piesele trebuie scoase din ambalaj(-aje) și așezate pe suprafața pregătită în prealabil pentru lucru.

Metoda de asamblare (în figura alăturată) se regăsește în manualul de utilizare principal.

AVERTISMENTE IMPORTANTE! Dacă piesele sunt avariate de o asamblare necorespunzătoare, aceste daune nu pot fi considerate drept revendicări. Este necesar ca montajul, de montajul și întreținerea produsului să fie efectuate de o persoană adultă.

Nu lăsați lângă surse de căldură, flăcări deschise, unități de aer condiționat. Evitați curățarea industrială dure, detergenții pentru sticlă și lustruiți. Materialele abrazive sau aspre pot deteriora suprafața.

De asemenea, verificați periodic starea tehnică a pieselor, dacă vreuna dintre piese este deteriorată sau are margini ascuțite, nu utilizați produsul până când defectele nu sunt eliminate sau piesele nu sunt înlocuite cu altele noi. În caz de întrebări, detectarea absenței sau deteriorarea unei piese înainte de asamblare - vă rugăm să nu returnați produsul, ci doar să contactați dealerul dumneavoastră.

Serviciul de reclamații se aplică defectelor de fabricație, nu deteriorărilor mecanice datorate utilizării produsului.

UPUTE ZA MONTAŽU I UPORABU (HR)

UPUTE ZA UPOTREBU. VAŽNO. PROČITATI POZORNO. SAČUVAJTE ZA UPOTREBU U BUDUĆNOSTI. VAŽNA UPOZORENJA! Samo za upotrebu u domaćinstvu. Čišćenjemlakomvodom s deterđentom i mekanomkropom. Za montažu svih elemenata izabratiravnu površinu.

PRIJE POČETKA MONTAŽE

VAŽNA UPOZORENJA! Molimo pogledajte sigurnosne upute navedene na kraju ovog priručnika |

Prije montaže pročitajte upute | Montaža svih dijelova mora biti izrađena u skladu suputama | Ne zaobilaziti nikakve korake.

DIJELOVI

Svi predmeti moraju biti izvučeni iz pakiranja i rasprostrti na prethodno pripremljenu radnu površinu.

Način montaže (crteži) nalazi se u glavnom uputstvu.

VAŽNA UPOZORENJA! Ako su dijelovi oštećeni nepravilnim sastavljanjem, takva oštećenja ne mogu se smatrati tvrdnjom. Montažu, demontažu i održavanje proizvoda može obavljati samo odrasla osoba.

Prije svake uporabe uvijek prvo provjeriti stabilnost proizvoda, da isti ne stvaraopasnostikodkorištenja, te da je pravilnomontiran. Uvijek pazite na djecu koja se igraju i ne ostavljajte djece bez nadzora odrasle osobe.

Ne ostavljajte u blizini izvora topline, otvorenog plamena, klima uređaja. Izbjegavajte oštra industrijska sredstva za čišćenje, sredstva za čišćenje stakla i sredstva za poliranje. Abrazivni ili grobi materijali mogu oštetiti površinu.

Također redovito provjeravajte tehničko stanje dijelova, ako je bilo koji dio oštećen ili ima oštre robove, nemojte koristiti proizvod dok se nedostaci ne uklone ili dijelovi ne budu zamijenjeni novima. U slučaju pitanja, otkrivanja odsutnosti ili oštećenja dijela prije sastavljanja - nemojte vraćati proizvod, samo kontaktirajte svog trgovca.

Usluga reklamacije odnosi se na nedostatke u proizvodnji, a ne na mehanička oštećenja nastala uporabom proizvoda.

UPUTSTVO ZA MONTAŽU I KORIŠĆENJE (SRB)

UPUTSTVO ZA KORIŠĆENJE.

VAŽNO. PROČITAJTE PAŽLJIVO. SAČUVAJTE ZA KASNIJE KORIŠĆENJE. VAŽNA UPOZORENJA!

Isključivo za kućnu upotrebu. Čišćenje: toplom vodom sa dodatkom deterđenta i mekom krpom. Svi elementi proizvoda moraju biti montirani na ravnoj površini. Uputstvo za montažu i spisak delova se nalaze u pakovanju.

PRE POČETKA MONTAŽE

VAŽNA UPOZORENJA! Pročitajte sva bezbednosna uputstva u ovom priručniku | Premontaže pročitajte uputstva | Montaža svih delovatreba da bude obavljena u skladu sa uputstvom | Ne preskačite bilo koji od koraka.

DELOVI

Sve delove izvaditi iz pakovanja i stavite na prethodno pripremljen radnu površinu.

Način montaže (crteži) je naveden u glavnom uputstvu.

VAŽNA UPOZORENJA! Ako su delovi oštećeni nepravilnim sklapanjem, takva oštećenja ne mogu se smatrati zahtevom. Montažu, demontažu i održavanje proizvoda može obavljati isključivo odrasla osoba.

Ne ostavljajte izvor toplote, otvorite vatru, klimatizacione jedinice. Izbegavajte oštre industrijske sredstva za čišćenje, čišćenje stakla i poliranje. Abrzivni ili grubi materijal mogu naneti štetu na površini.

Takođe proverite tehničko stanje delova ako je jedan od delova oštećen ili ima oštre ivice, ne koristite proizvod dok ne uklonite oštećenja ili delove sa novim. U slučaju pitanja, pronalaženje odsustva ili oštećenja dela pre montaže - ne vratite proizvod, samo se obratite svom prodavcu.

Služba za žalbu odnosi se na proizvodne nedostatke, a ne mehaničku štetu zbog upotrebe proizvoda.

MONTAVIMO IR NAUDOJIMO INSTRUKCIJA (LT)

NAUDOJIMO INSTRUKCIJA. SVARBU! PRAŠOME ĮDĖMIAI PERSKAITYTI. REKOMENDUOJAMA PASILIKTIPAKARTOTINAM

PANAUDOJIMUI. SVARBŪS ĮSPĖJIMAI! Tik buitiniam naudojimui. Valymas: minkštu skudurėliu, šiltu vandeniu su valymo skysčiu.

PRIEŠ MONTAVIMO PRADŽIĄ

SVARBŪS ĮSPĖJIMAI!

Perskaitykite visas šiame vadove pateiktas saugos instrukcijas | Prieš montavimą reikia susipažinti su instrukcija | Visų elementų montavimas turi būti atliktas pagal instrukciją | Negalima praleisti nei vieno etapo.

DALYS

Visus elementus reikia išimti iš pakuotės (-čių) ir sudėti ant anksčiau darbui paruošto paviršiaus.

Montavimo būdas (piešiniai) yra pagrindinėje instrukcijoje.

SVARBŪS ĮSPĖJIMAI! Jei dalys pažeistos netinkamai surinkus, tokia žala negali būti laikoma pretenzija. Montavimą, de montavimą bei priežiūrą turi atlikti suaugęs asmuo. Prieš naudojant visada patikrinkites augumą, produkto stabilumą ir jo teisingą montavimą. Niekada nepalikite vaiko be priežiūros, žaidžiantys vaikai visada reikalauja suaugusioas mens priežiūros.

Nepalikite šalia šilumos šaltinių, atviros liepsnos, oro kondicionavimo įrenginių. Venkite griežtų pramoninių valiklių, stiklo valiklių ir blizginimo priemonių. Abrazyvinė arba šiurkšti medžiaga gali pažeisti paviršių.

Taip pat reguliariai tikrinkite detalių techninę būklę, jei kuri nors dalis pažeista ar turi aštrių briaunų, nenaudokite gaminio, kol nepašalinsite defektų arba nepakeiskite detalės naujomis. Jei kyla klausimų, prieš surenkant aptinkama dalies nebuvimas ar sugadinimas – prašome negrąžinti gaminio, tiesiog susisiekite su pardavėju.

Skundų paslauga taikoma gamybos defektams, o ne mechaniniams pažeidimams dėl prekės naudojimo.

MONTĀŽAS UN LIETOŠANAS INSTRUKCIJA (LV)

LIETOŠANAS INSTRUKCIJA. SVARĪGI! LŪDZAM UZMANĪGI IZLASĪT! IETEICAMS SAGLABĀT TURPMĀKAI LIETOŠANAI. SVARĪGS

BRĪDINĀJUMS! Tikai lietošanai mājāsaimniecībā. Tīrīšana: ar mīkstu drānu samitrinātu remdenā ūdenī, kuram pievienots mazgāšanas līdzeklis.

Visus produktus elementus nepieciešams montēt uz plakanas virsmas.

PIRMS MONTĀŽAS SĀKUMA

SVARĪGS BRĪDINĀJUMS! Nepieciešams iepazīties ar drošības norādījumi uzrādīties šīs instrukcija sbeigās | Pirms montāžas sākuma

nepieciešams iepazīties ar instrukciju | Visu elementu montāžu nepieciešams veikt saskaņā ar instrukciju | Nedrīkst izlaist nevienu posmu.

DALĀS

Visuselementus nepieciešams ņemt no iepakojuma (-iem) un izvietot uz iepriekš sagatavotas darbvirsmas.

Montāžas veids (zīmējumi) atrodas galvenajā Instrukcijā.

SVARĪGS BRĪDINĀJUMS! Ja detaļas ir bojātas nepareizas montāžas rezultātā, šādus bojājumus nevar uzskatīt par atlīdzību Produkta montāžu, demontāžu kā arī konservāciju nepieciešams veikt tikai pieaugušai personai.

Neatstājiet siltuma avotu, atklātas liesmas, gaisa kondicionēšanas iekārtu tuvumā. Izvairieties no skarbiem rūpnieciskiem tīrīšanas līdzekļiem, stikla tīrīšanas un pulēšanas līdzekļiem. Abrazīvs vai raupjš materiāls var sabojāt virsmu.

Regulāri pārbaudiet arī detaļu tehnisko stāvokli, ja kāda no detaļām ir bojāta vai ar asām malām, nelietojiet precī līdz defektu novēršanai vai detaļu nomaiņai pret jaunām. Ja rodas jautājumi, pirms montāžas tiek konstatēta daļas trūkums vai bojājums - lūdzu, neatgrieziet precī, vienkārši sazinieties ar savu izplatītāju.

Sūdzību dienests attiecas uz ražošanas defektiem, nevis uz mehāniskiem bojājumiem preces lietošanas dēļ.

PAIGALDUS- JA KASUTAMISJUHEND (EST)

KASUTUSJUHEND. TAHTIS! LUGEGE TAHELEPANELIKULT LABI! HOIDKE ALLES HILISEMAKS KASUTUSEKS. OLULISIHUIATUSI!

Kasutamiseks ūksnes kodumajapidamises. Puhastamine: soojavee, detergendi ja pehme lapiga. Kõik toote elemendid tuleb paigaldada tasasel alusel.

ENNE PAIGALDAMIST

OLULISI HOIATUSI! Tutvuge kõesoleva juhendi lõpuosas toodud ohutusjuhestega | Enne paigaldamist alustamist tutvuge juhendiga | Kõikide elementide paigaldamist tuleb teostada vastavalt juhendile | Ärge jätkke vahele ühtegi etappi

ELEMENDID

Võtke kõik elemendid pakendi(te)st japaangeneed eelnevalt tööks ettevalmistatud pinnale. | Kuuri paigaldamise (joonised) on toodud peamises Juhendis.

OLULISI HOIATUSI! Kui osi on vääralt kokkupanekul kahjustatud, ei saa seda kahju käsitada. Toodet võib paigaldada, lahti monteerida ja hooldada ūksnes täiskasvanu. Kontrollige enne kasutamist alati toote turvalisust,

Ärge jätkke soojusallikate, lahtise tule, kliimaseadmete lähedusse. Vältige tugevatoimelisi tööustuslikke puhastus-, klaasipuhastus- ja poleervahendeid. Abrasiivne või kare materjal võib pinda kahjustada.

Kontrollige regulaarselt ka osade tehnilist seisukorda, kui mõni detail on kahjustatud või teravate servadega, ärge kasutage toodet enne, kui defektid on kõrvaldatud või osad asendatud uutega. Küsimuste korral, osa puudumise või kahjustuse avastamisel enne kokkupanekut - palun ärge tagastage toodet, vaid võtke ühendust edasimüüjaga.

Reklamatsiooniteenus kehtib tootmisdefektide, mitte toote kasutamisest tingitud mehaaniliste vigastuste kohta.

INSTRUKTSII ZA SGLOBYAVANE I UPOTREBA (BG)

INSTRUKTSII ZA UPOTREBA. VAZHNO! MOLYA, PROCHETETE VNIMATELNO! PREPORŪCHVA ZAPAZETE ZA BŪDESHTA UPOTREBA.

VAZHNO SŪOBSHTENIE! Produktŭt e za domashna upotreba. Pochistvane: khladka voda sŭs sapun i meka kŭrpa. Sglobete vsichki chasti na produkta vŭrkhu ravna i ravna povŭrkhnost.

PREDI ZAPOCHVANE NA SGLOBYAVANETO

VAZHNO SŪOBSHTENIE! Prochetete vsichki instruktsii za bezopasnost v tova rŭkovodstvo | Prochetete tova rŭkovodstvo, predi da zapochnete sglobyavaneto | Sglobyavaneto na vsichki chasti tryabva da se izvŭrshi sŭglasno instruktsiite s izobrazheniya. Ne propuskaite nito edin ot etapite.

CHASTI

Izvadete vsichki chasti ot opakovkata(ite) i gi postavete vŭrkhу predvaritelno podgotvena rabotna povŭrkhnost. Metodŭt na sglobyavane (snimki) e daden v osnovnite instruktsii.

VAZHNI PREDUPREZHDIYA! Ako chastite sa povredeni poradi nepravilno sglobyavane, тази повреда не може да се приеме като оплакване. Montazhŭt, demontazhŭt i poddrŭzhkata na produkta se izvŭrshvat samo ot vŭzrasten. Predi upotreba vinagi proveryavaite bezopasnostta, stabilnostta na produkta i pravilniya montazh. Nikoga ne ostavyaite detsa bez nadzor, igraeshtite detsa tryabva vinagi da bŭdat nablyudavani ot vŭzrasten.

Ne ostavyaite v blizost do iztochnitsi na toplina, otkrit plamŭk, klimatichni instalatsii. Izbyagvaite agresivnite promishleni pochistvashti preparati, pochistvashti preparati za stŭklo i lakove. Abrazivni ili grubi materialy mogat da povredyat povŭrkhnostta.

Proveryavaite redovno i tehnicheskoto sŭstoyanie na chastite, ako nyakoya ot chastite e povredena ili ima ostrы rŭbove, ne izpolzvaite produkta, dokato defektite ne bŭdat ot-straneni ili chastite ne bŭdat zameneni s novi. V sluchaŭ na vŭprosi, otkrivane na lipsa ili povreda na chast predi sglobyavane - molya, ne vrŭshaite produkta, prosto se svŭrzhete s vashiya tŭrgovets.

Uslugata za reklamatsiya se otnasya za proizvodstveni defekti, a ne za mekhanichni povredi v rezultat na izpolzване на produkta.

ПОСІБНИК ПО МОНТАЖУ І ЕКСПЛУАТАЦІЇ (UA)

ІНСТРУКЦІЯ З ВИКОРИСТАННЯ. ВАЖЛИВО.ПРОХАННЯ УВАЖНО ПРОЧИТАТИ. РЕКОМЕНДУЄТЬСЯ ЗБЕРЕГТИ ДЛЯ ПОДАЛЬШОГО ВИКОРИСТАННЯ.ПОПЕРЕДЖЕННЯ

ВАЖЛИВО! Для побутового використання. Рекомендації по догляду: чистити за допомогою м'якої серветки теплою водою з доданням ммиючого засобу. Всі елементи виробу необхідно збирати нарівній поверхні. Окремі елементи і Болти повинні бути встановлені вручну, і тільки в кінці монтажу затягнуті за допомогою інструментів.

ПЕРШ НІЖ ПОЧИНАТИ МОНТАЖ

ПОПЕРЕДЖЕННЯ ВАЖЛИВО Прочитайте всі інструкції з техніки безпеки в цій інструкції | Перш ніж приступати до монтажу необхідно ознайомитися з інструкцією |

Монтаж усіх елементів має бути виконаний згідно з інструкцією.

ЧАСТИНИ

Усі предмети мають бути витягнуті з упаковки (-ок) і розкладені на заздалегідь підготовлені й робочій поверхні.

ПОПЕРЕДЖЕННЯ ВАЖЛИВО! Якщо деталі пошкоджені через неправильне складання, таке пошкодження не може розглядатися як претензія. Монтаж, демонтаж та обслуговування виробу повинні здійснюватися виключно дорослими.

Не залишайте джерело тепла, відкритий вогонь, кондиціонер. Уникайте суворих промислових очищувачів, очищувачів скла та полірувальників. Абразивний або грубий матеріал може спричинити пошкодження поверхні.

Також перевірте технічний стан деталей, чи одна з деталей пошкоджена або має гострі краї, не використовуйте продукт, поки ви не видалите дефекти або деталі з новими. Що стосується питань, пошук відсутності або пошкодження частини перед складанням - будь ласка, не повертайте продукт, просто зверніться до свого дилера.

Служба скарг стосується дефектів виробництва, а не механічних пошкоджень через використання продукту.

ИНСТРУКЦИЯ ПО УСТАНОВКЕ И ИСПОЛЬЗОВАНИЮ (РУС)

РУКОВОДСТВО ПО МОНТАЖУ И ЭКСПЛУАТАЦИИ

ИНСТРУКЦИЯ ПО ИСПОЛЬЗОВАНИЮ. ВАЖНО.ПРОСЬБА ВНИМАТЕЛЬНО ПРОЧИТАТЬ. РЕКОМЕНДУЕМ СОХРАНИТЬ ДЛЯ ДАЛЬНЕЙШЕГО ИСПОЛЬЗОВАНИЯ.

ПРЕДУПРЕЖДЕНИЯ ВАЖНО! Для бытового использования. Рекомендации по уходу: чистить с помощью мягкой тканевой салфетки теплой водой с добавлением моющего средства. Все элементы изделия необходимо собирать на плоской поверхности.

ПРЕЖДЕ ЧЕМ НАЧИНАТЬ МОНТАЖ, ПРЕДУПРЕЖДЕНИЯ ВАЖНО!

Прочитайте все инструкции по технике безопасности в этом руководстве. | Прежде чем приступать к монтажу необходимо ознакомиться с руководством | Монтаж всех элементов должен быть выполнен согласно руководству | Ни один из этапов не должен быть пропущен

ЧАСТИ

Все предметы должны быть извлечены из упаковки (-ок) и разложены заранее подготовленной рабочей поверхности. Способ монтажа домика (рисунок-схемы) находится в главной инструкции.

ПРЕДУПРЕЖДЕНИЯ ВАЖНО! Если детали повреждены в результате неправильной сборки, такой ущерб не может рассматриваться как претензия. Требуется сборка, разборка и обслуживание изделия исключительно взрослыми.

Не оставляйте вблизи источников тепла, открытого огня, кондиционеров. Избегайте агрессивных промышленных чистящих средств, средств для мытья стекол и полиролей. Абразивный или грубый материал может повредить поверхность.

Также регулярно проверяйте техническое состояние деталей, если какие-либо из деталей повреждены или имеют острые края, не используйте изделие до устранения дефектов или замены деталей на новые. В случае возникновения вопросов, обнаружения отсутствия или повреждения детали перед сборкой - просьба не возвращать товар, а только обратиться к вашему дилеру.

Претензионная служба распространяется на производственные дефекты, а не на механические повреждения, вызванные использованием товара.

Distributor/ Distributor / Dystrybutor/ Forgalmazó / Distributor/ Distributor/ Distributer/
Distributer/ Platintojas/ Izplatitājs/ Turustaja/ Дистриб'ютор/ Дистрибьютор:
ROJAPLAST s.r.o.

Bohouňovice I, čp. 79, 280 02 Kolín, tel: +420 321 761 361

<https://www.rojaplast.com/>



DISTRIBUTOR:

ROJAPLAST s.r.o.

Bohouňovice I, čp. 79

280 02 Kolín, CZ

Tel.: 00420 321 761 361

E-mail: roja@rojaplast.com