

WAYLOR

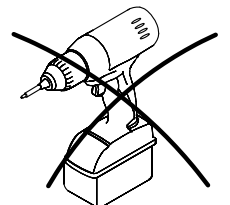

			✓
①	1	580x560x435	
②	1	515x230x430	
③	1	455x190x410	

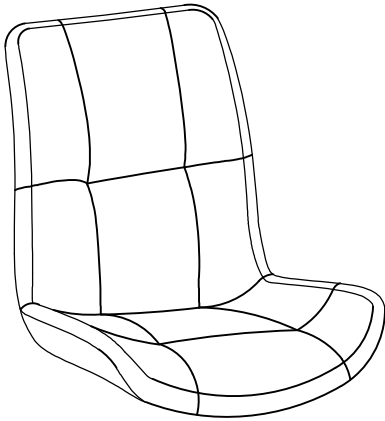

X1

①

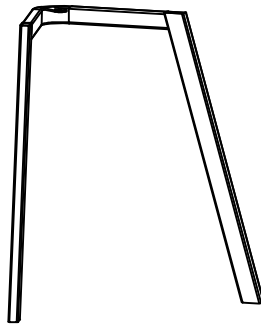

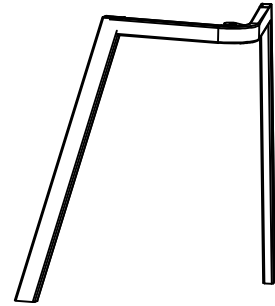

X1

②



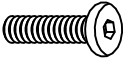

X1

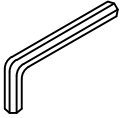
③



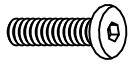

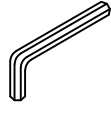
A × 2	B × 4	C × 6	D × 6	E × 1
				
M6 × 20	M6 × 40	φ 10 / φ 6	φ 16 / φ 6	4

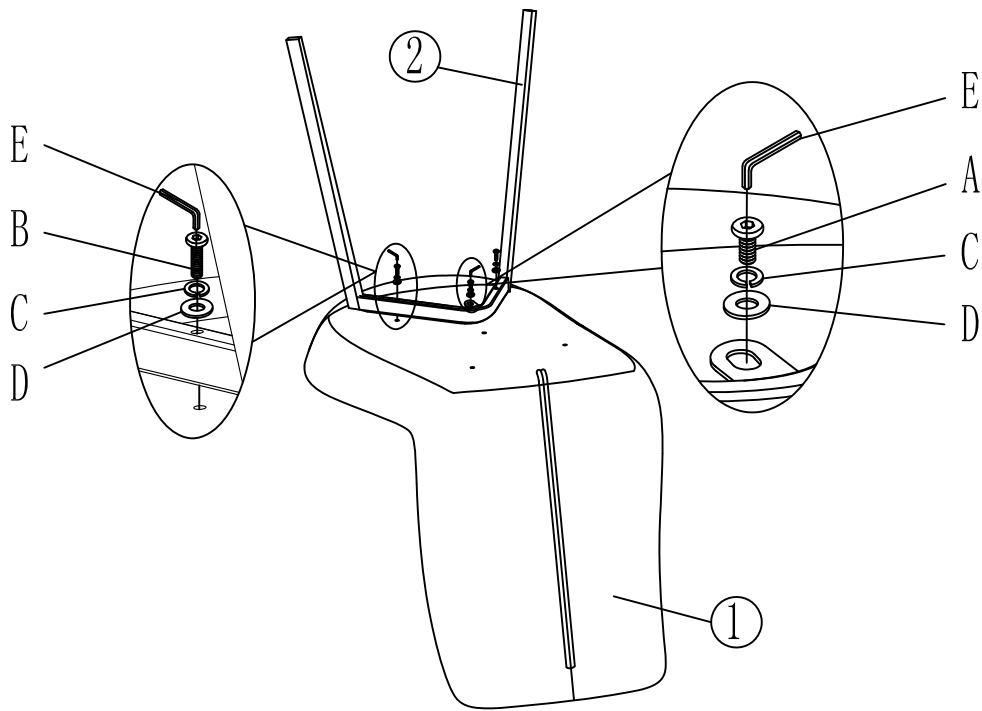
1

A×1  M6×20	B×2  M6×40	C×3  φ 10/φ 6	D×3  φ 16/φ 6	E×1  4
---	---	--	---	---

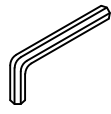

2

A×1  M6×20	B×2  M6×40	C×3  φ 10/φ 6	D×3  φ 16/φ 6	E×1  4
---	---	--	---	---

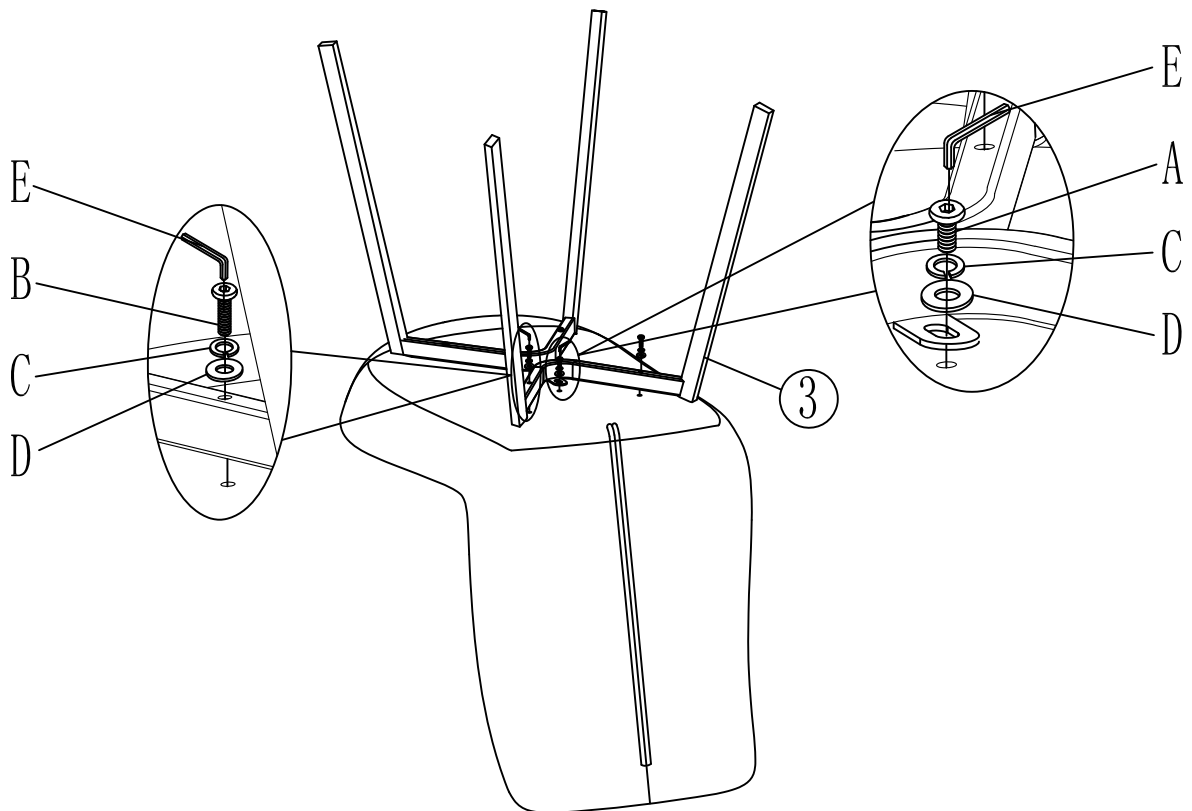

3



4

