

Esquema de Montagem

Pós-produção

Atenção! Não poderá haver alterações sem aprovação do Cliente

Assembly Instruction

Post-production

Attention! no changes can occur without customer approval

Folha de montaje

Pós-producción

Atención! No puede haber cambios sin aprobación del cliente

NOTICE DE MONTAGE
 ASSEMBLY INSTRUCTIONS
 MONTAGEANLEITUNG
 ISTRUZIONI DI MONTAGGIO
 INSTRUÇÕES DE MONTAGEM
 INSTRUCCIONES DE MONTAJE
 UPUTE ZA MONTAZU
 MONTAJ TALIMATI

11610
 COMODA 3C2c
 COMMUNE 3T2t



EAN CODE : 8435178305091

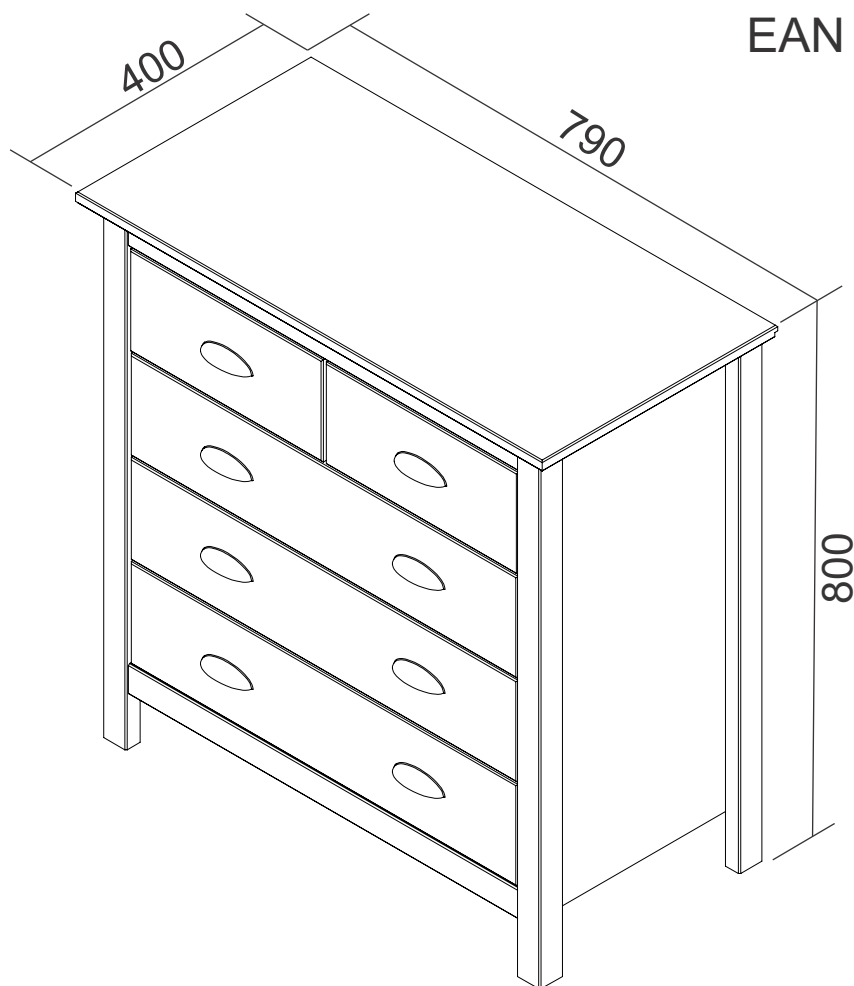

AVANT DE COMMENCER, SE
 REPORTER AUX CONSEILS
 DE MONTAGE EN ANNEXE

**BEFORE STARTING, REFER
 TO THE ASSEMBLING ADVICE
 IN ANNEX**

VOR DER MONTAGE,
 BEILIEGENDE ANWEISUNGEN
 BEFOLGEN.

PRIMA DI COMINCIARE
 LEGGETE LE ISTRUZIONI DI
 MONTAGGIO

ANTES DE COMENÇAR, ADIAR
 SE AOS CONSELHOS DE
 MONTAGEM EM ANEXO

**ANTES DE EMPEZAR
 CONSULTE LOS CONSEJOS
 PARA EL MONTAJE**

PRIJE POČETKA MONTAŽE
 MOLIMO PAŽLJIVO
 PROČITAJTE UPUTE ZA
 MONTAŽU

**BASLAMADAN ÖNCE,
 EKTEKI MONTAJ TALIMATLARINI
 INCELEYINIZ**

| Tamaño de la caja Dimensions colis | Peso bruto Poids brut | Peso neto Poids net |
|---------------------------------------|--------------------------|------------------------|
| 820 x 465 x 142mm | 19,50 Kg | 18,50 Kg |

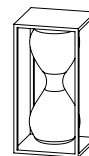
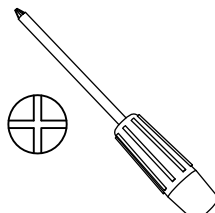
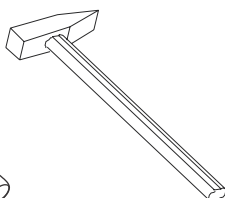
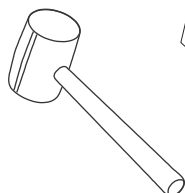
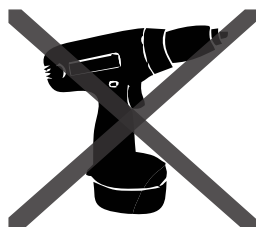

45min.

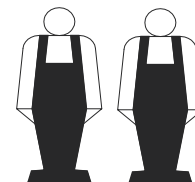

max.
30 kg

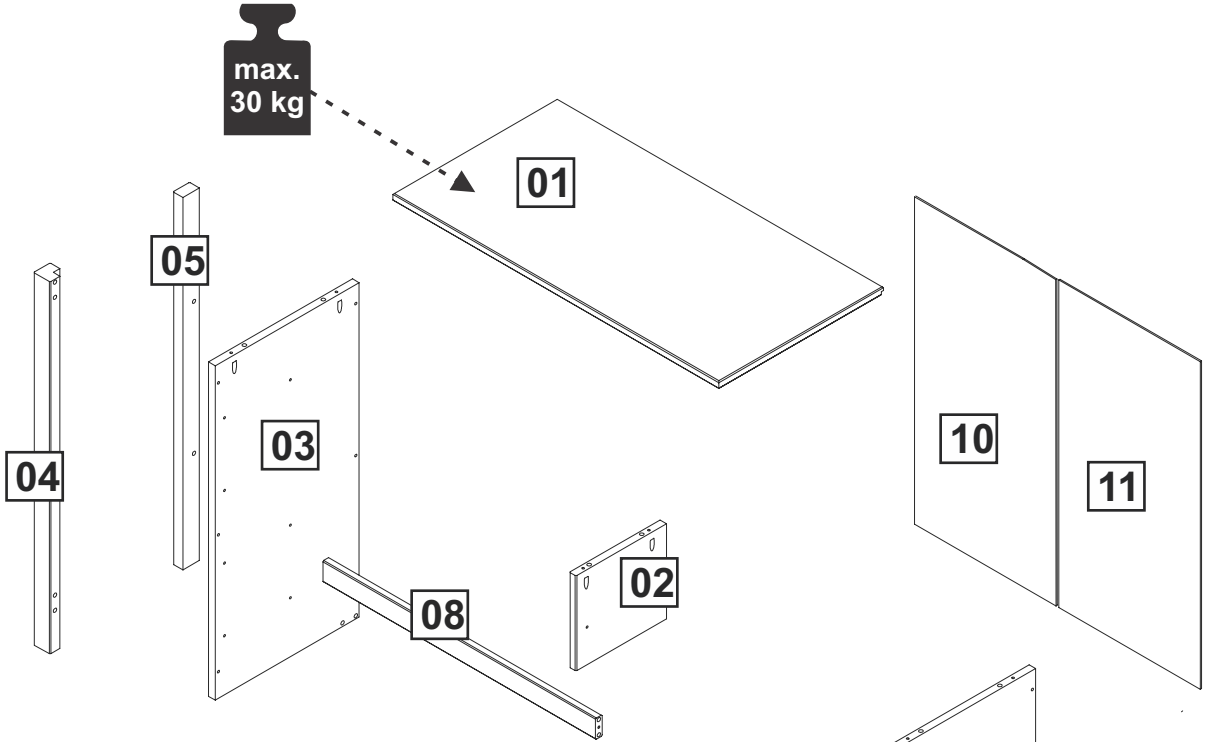

max.
5 kg

2x

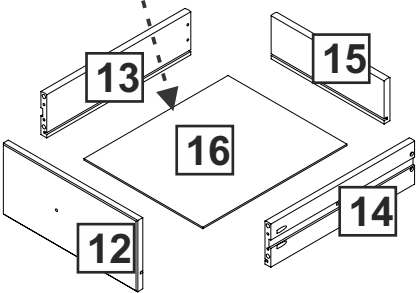

max.
5 kg

3x

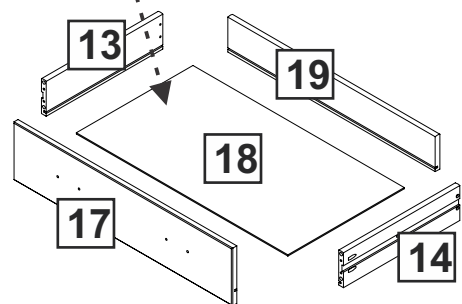

05

07

10

11

02

08

09

06

08

05





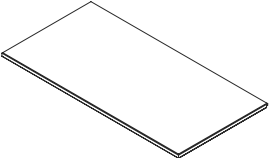
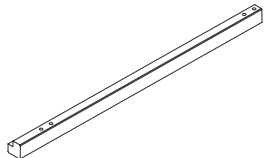
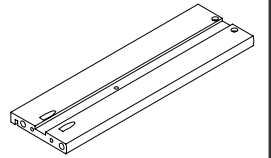
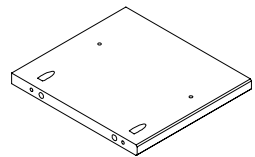
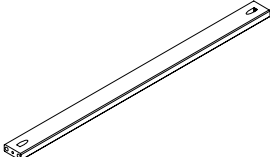
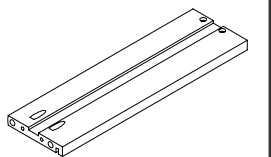
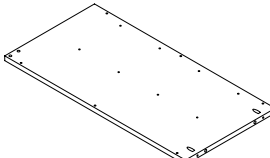
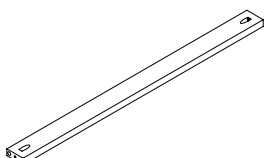
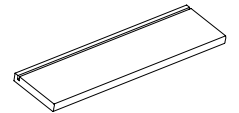
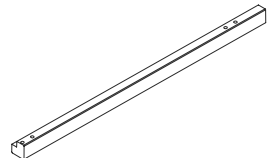
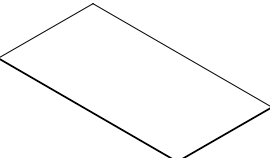
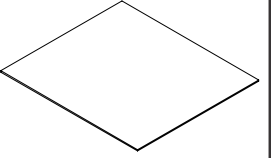
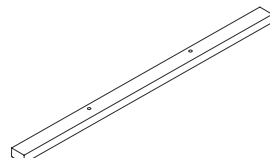
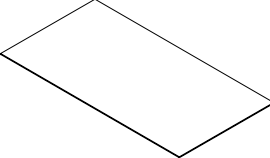
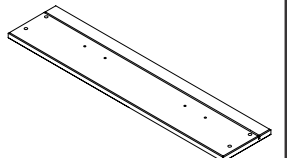
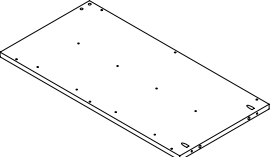
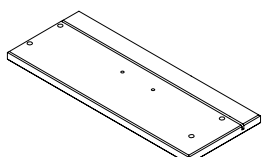
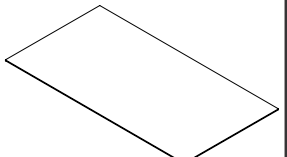
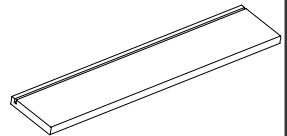

04

03



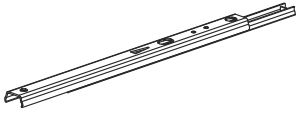

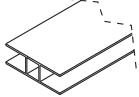

LISTADO DE PIEZAS - COMPOSANTS - PARTS LIST

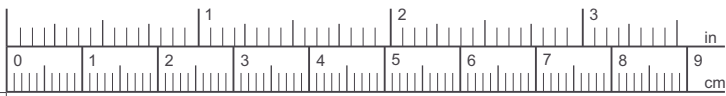
| | | | | | | | | |
|----|---|------|----|---|------|----|---|------|
| 01 |  | 01pc | 07 |  | 01pc | 13 |  | 05pc |
| 02 |  | 01pc | 08 |  | 02pc | 14 |  | 05pc |
| 03 |  | 01pc | 09 |  | 01pc | 15 |  | 02pc |
| 04 |  | 01pc | 10 |  | 01pc | 16 |  | 02pc |
| 05 |  | 02pc | 11 |  | 01pc | 17 |  | 03pc |
| 06 |  | 01pc | 12 |  | 02pc | 18 |  | 03pc |
| | | | | | | 19 |  | 03pc |

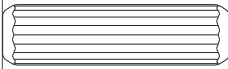
HERRAJES - QUINCALLERIE - HARDWARE

| | | | | | |
|----------|---|-----------|----------|---|-----------|
| G |  | 08 | J |  | 04 |
| H |  | 10 | L |  | 02 |
| I |  | 01 | M |  | 01 |

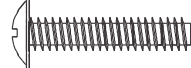
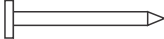
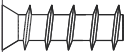

| | | |
|--------------|---|---------------|
| A x42 |  | 8,0x30 |
| B x64 |  | 4,0x30 |
| C x16 |  | 6,0x10 |
| D x10 |  | M4x12 |
| E x16 |  | M4x22 |
| F x24 |  | 1,8x20 |
| K x04 |  | 6,0x20 |
| N x01 |  | 3,5x14 |

01

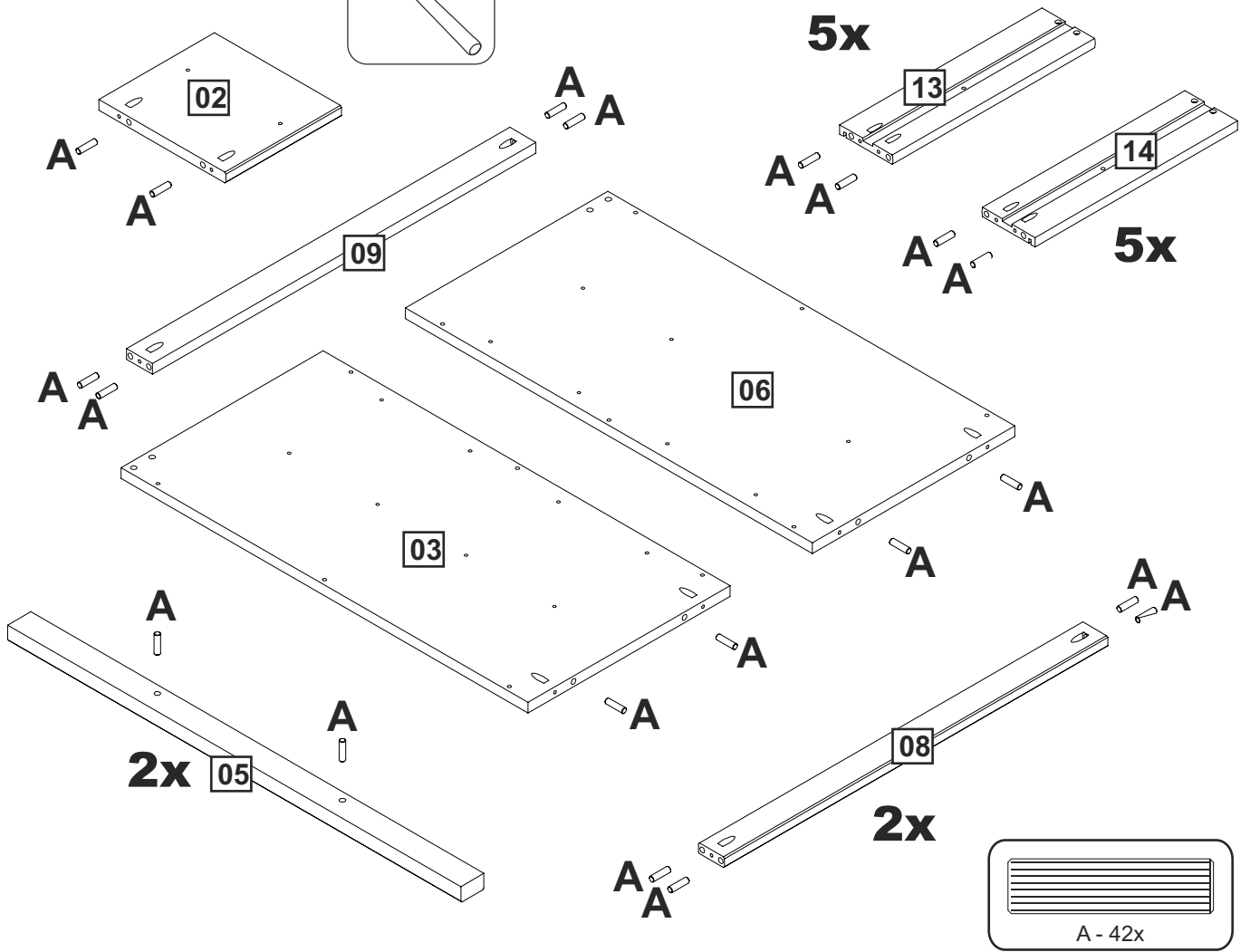

02

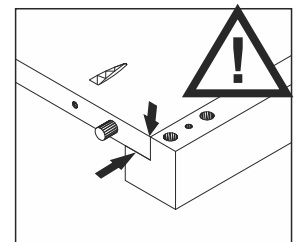
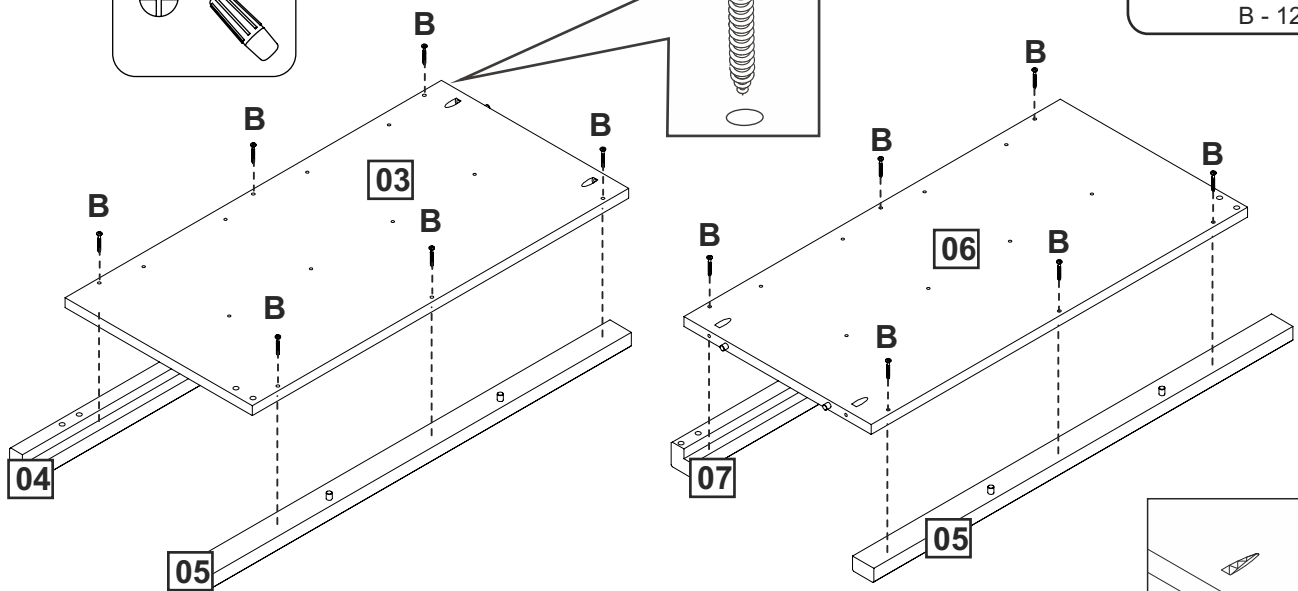
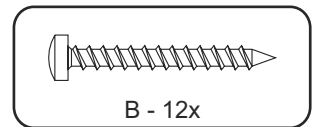
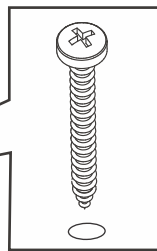
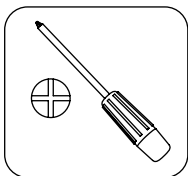

03

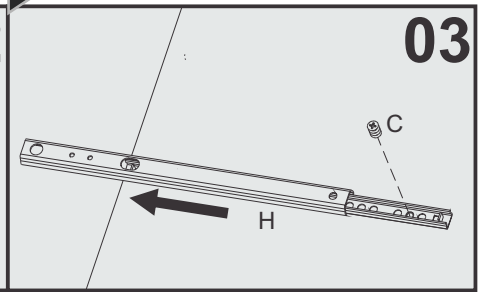
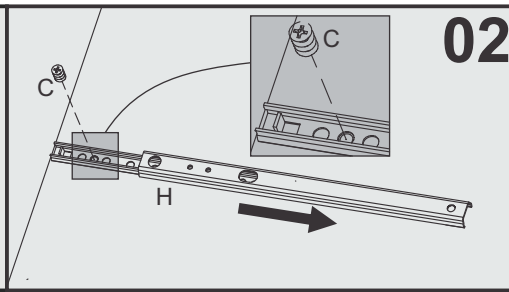
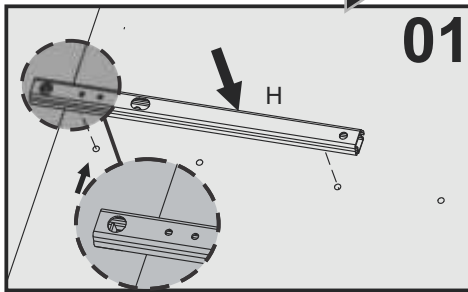
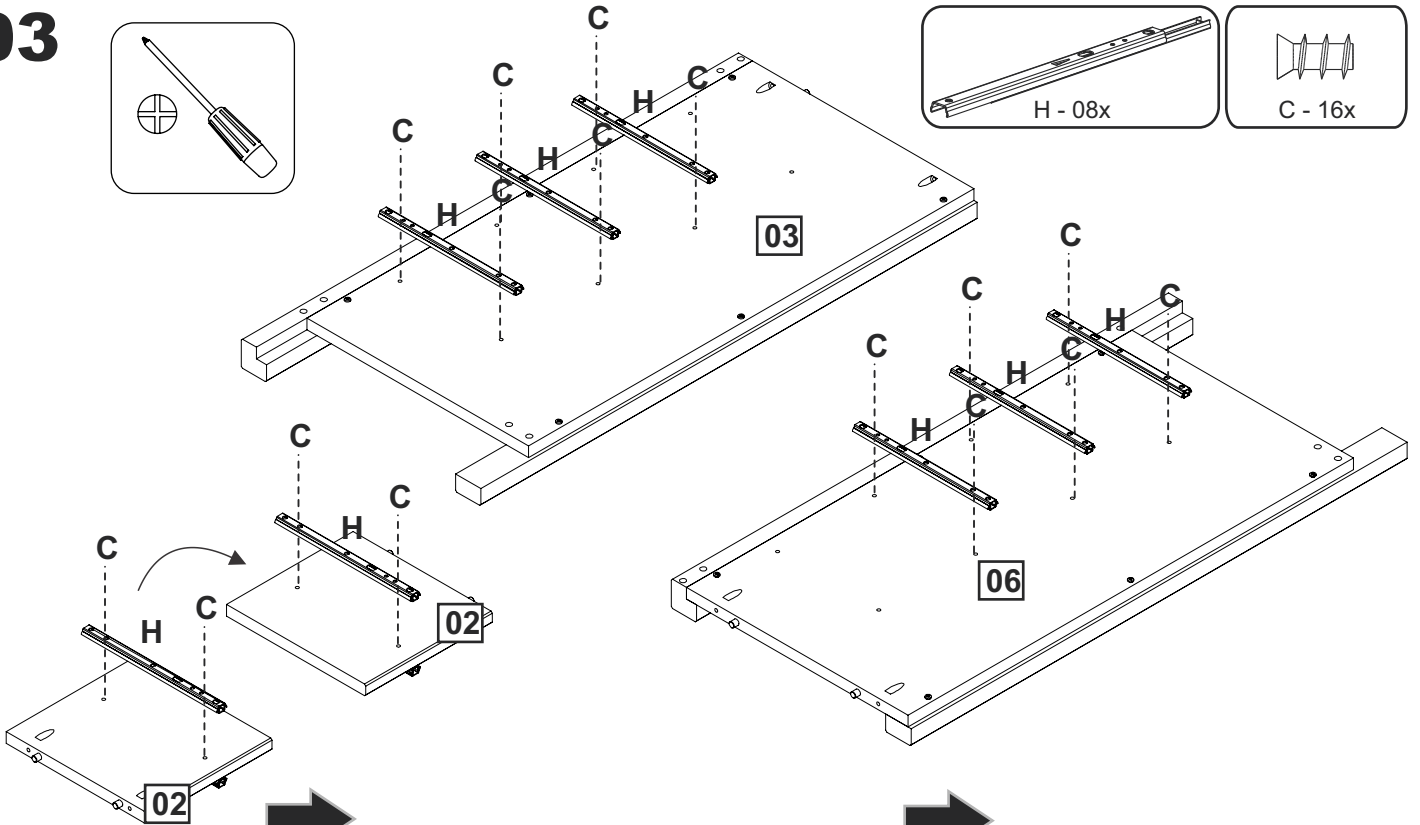
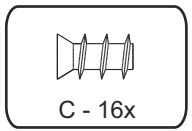
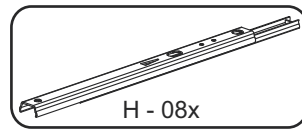
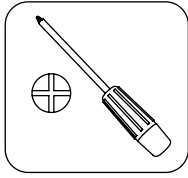

04

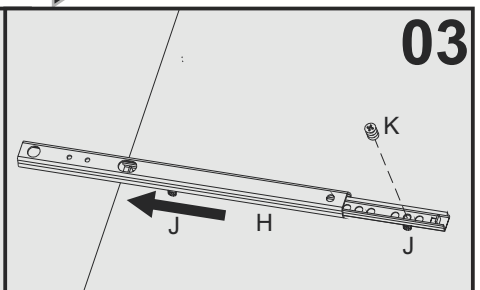
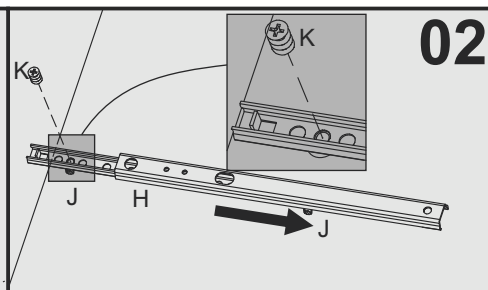
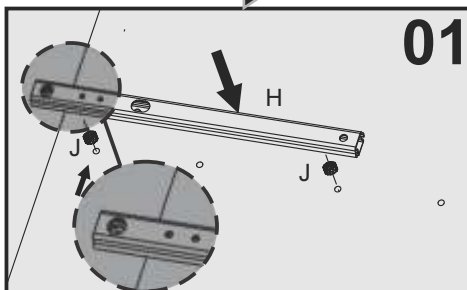
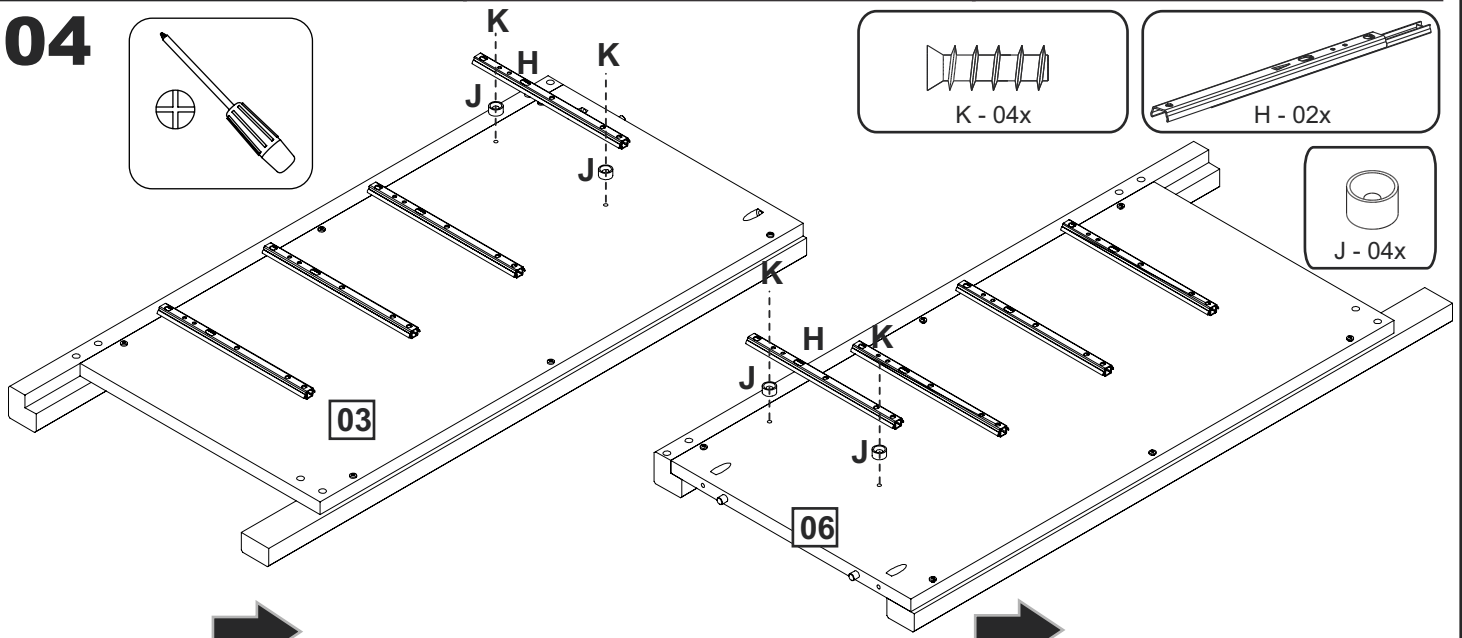
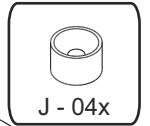
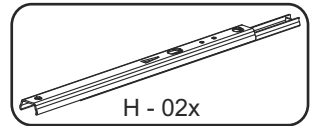
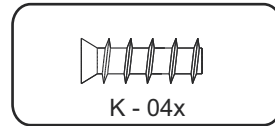
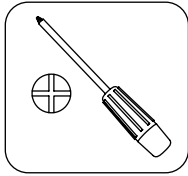

05

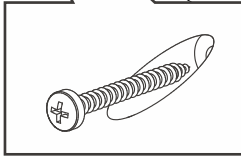
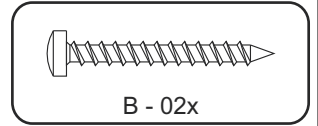
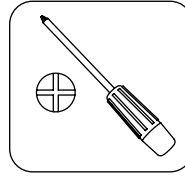
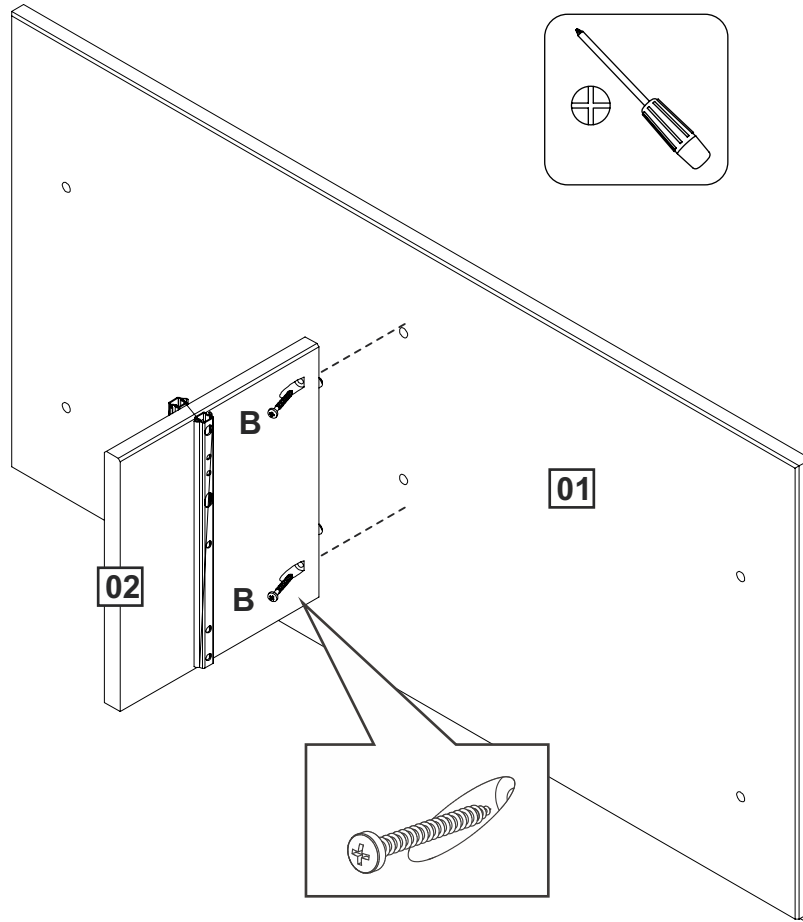

06

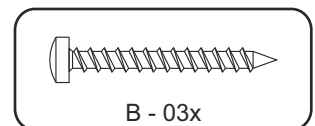
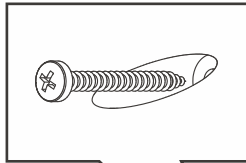
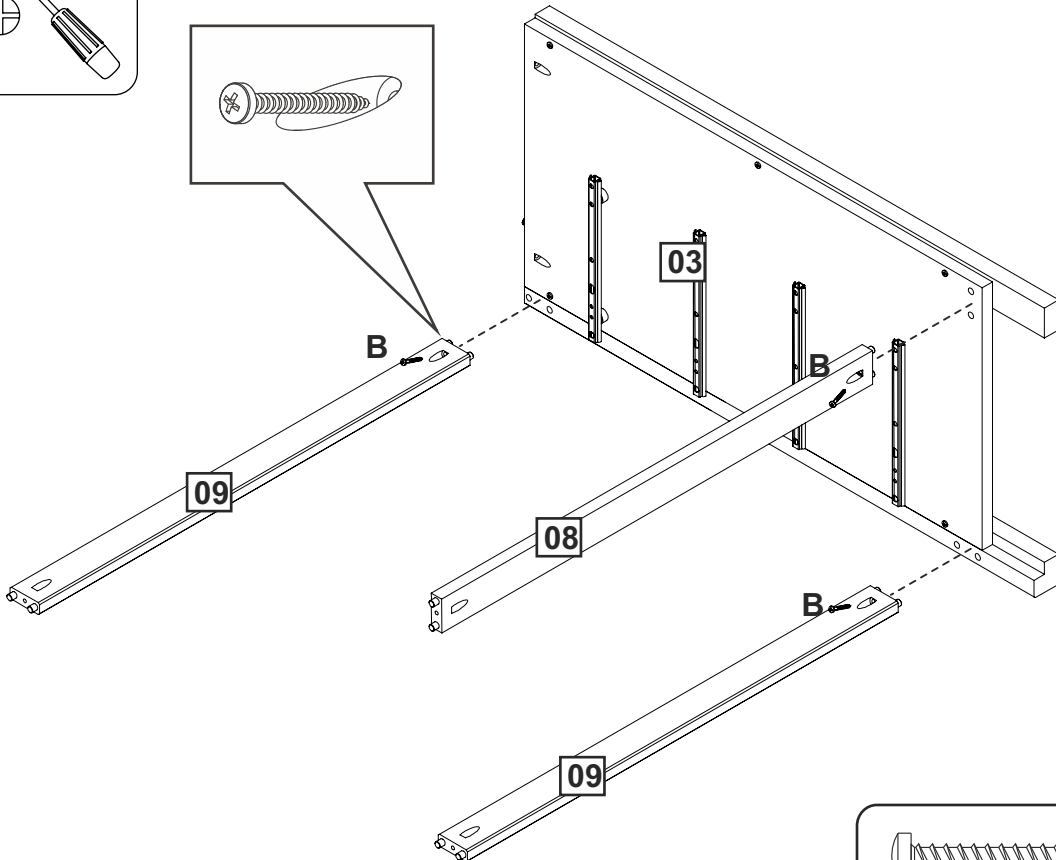
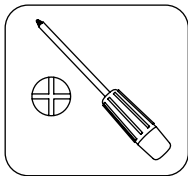

07

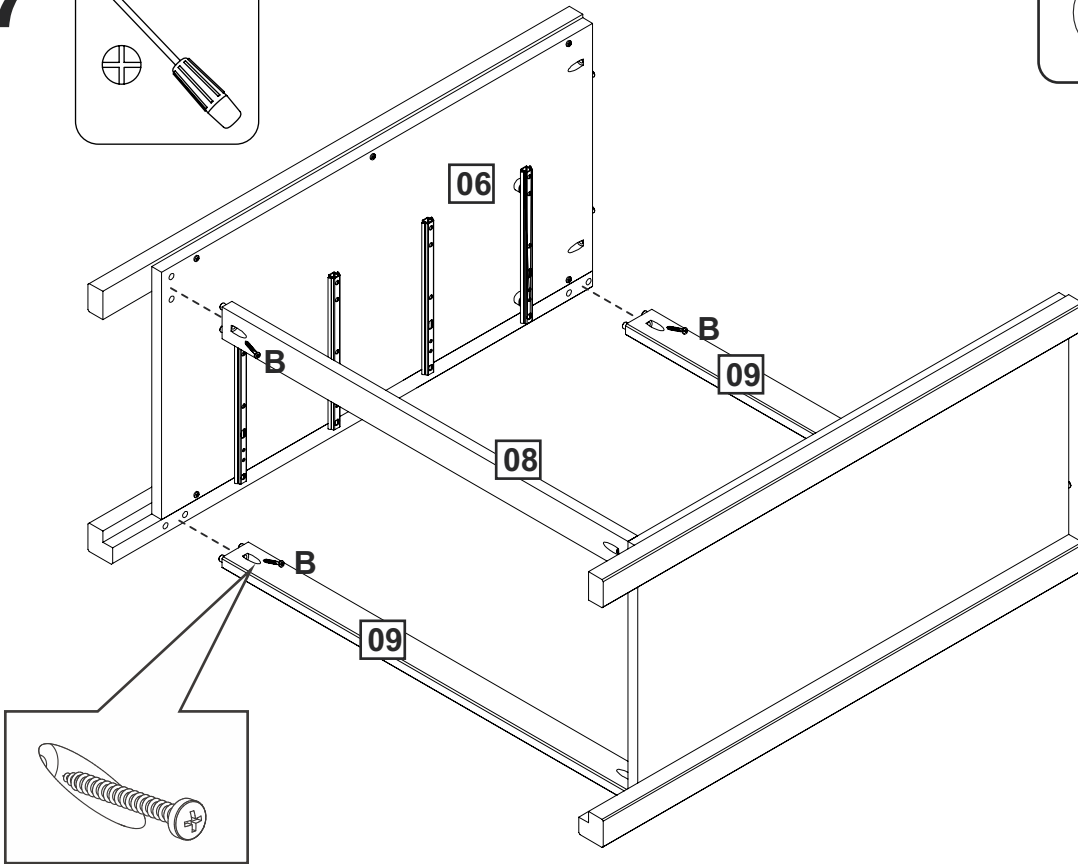
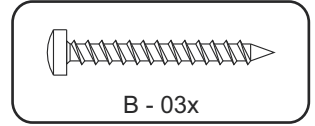
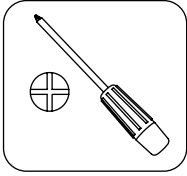

08

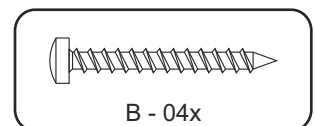
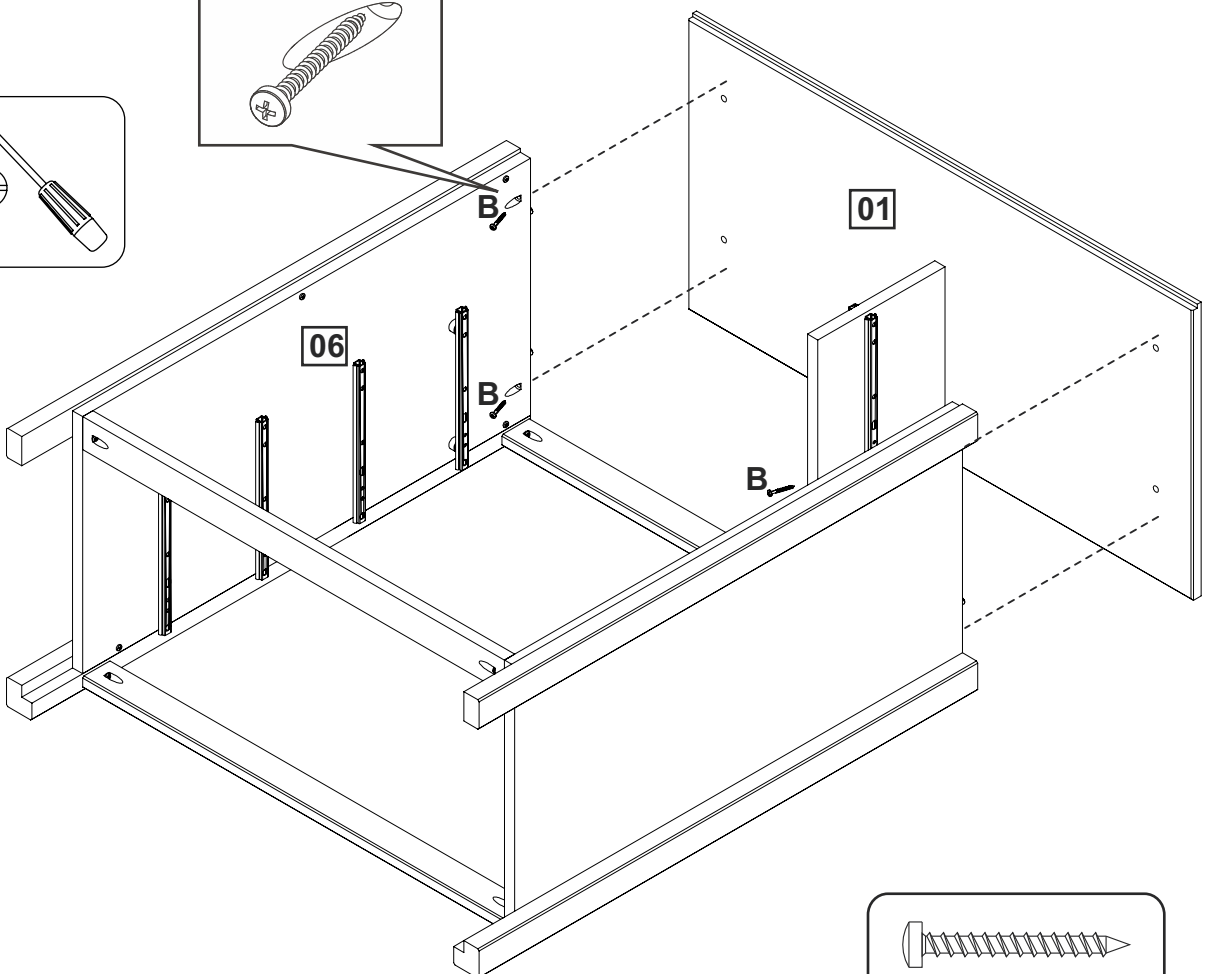
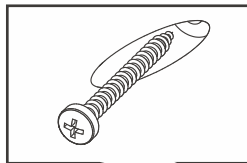
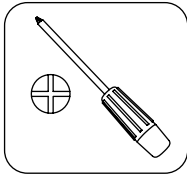

09

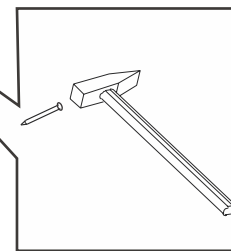
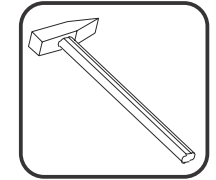
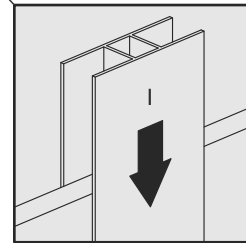
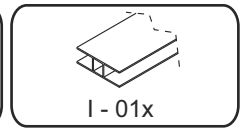
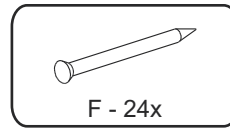
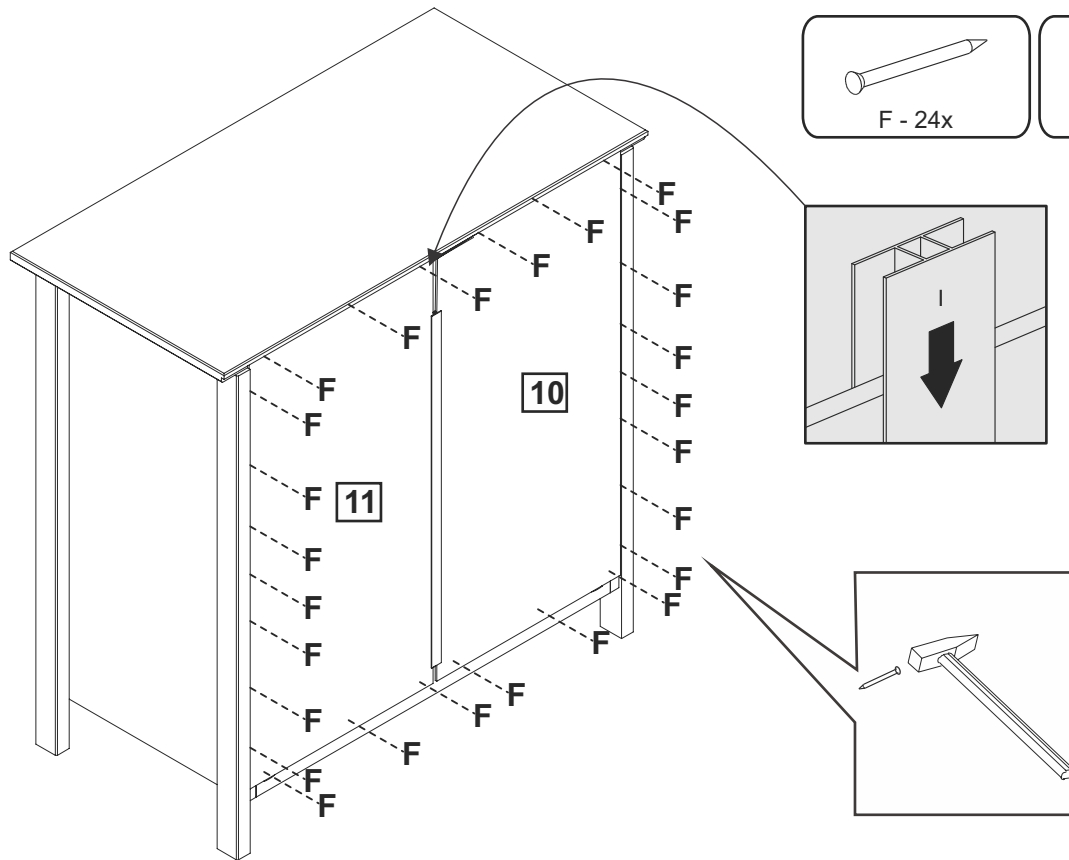

FIXATION MURALE OBLIGATORIE

UTILISEZ DES VIS ET DES CHEVILLES ADAPTÉES A VOS MURS

Il existe une grande diversité de types de murs ou cloisons, c'est la raison pour laquelle nous ne pouvons vous fournir une quincaillerie adaptée à votre mur. Il est nécessaire d'identifier le type de paroi à laquelle vous allez fixer ce produit afin de vous procurer les fixations appropriées. En cas de besoin, adressez vous à un magasin spécialisé pour conseil

OBLIGATORIO FIJAR A LA PARED

UTILICE LOS TORNILLOS Y TACOS ADECUADOS PARA SU MURO

Existe una gran diversidad de muros y paredes, por esta razón no podemos proporcionarle el herraje adecuado para su pared. Primero, es necesario identificar el tipo de pared para luego utilizar el herraje adecuado. En caso de duda, diríjase a una tienda especializada para más información.

OBLIGATORY FIX ON THE WALL

USE SCREWS AND PLUGS SUITABLES FOR YOUR WALL

Due to the wide diversity of wall or partition types, we cannot provide you with suitable attachment fixtures . To determine which attachment fixtures to use, you will need to identify the type of wall to which you will be fixing this product. If you have whatever doubt, please, go to one specialised shop for further information.

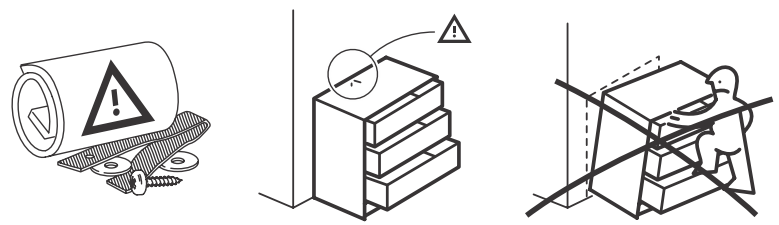

French

IMPORTANT: Pour éviter le basculement accidentel du meuble, la fixation du meuble au mur est obligatoire.

La visserie nécessaire pour la jonction mur/meuble, dépendante de la nature du mur, n'est pas fournie. En cas de doute, consulter un spécialiste

English

IMPORTANT: To avoid the accidental tip-over of the furniture, the fixing of the furniture on the wall is mandatory.

The needed hardware for the junction wall/furniture, depending of the nature of the wall, is not provided. If any doubt, consult a specialist.

Spanish

IMPORTANTE: Para evitar el vuelco accidental de los muebles, es obligatorio fijarlos en la pared.

El tipo de tornillos necesarios para fijar el mueble a la pared, dependen del material de la pared, no se suministran. En caso de duda, consulte a un especialista

Portuguese

IMPORTANTE: Para evitar a queda accidental de móveis, é obrigatório fixá-los na parede. O tipo de parafusos para a fixação de mobiliário na parede, depende do material de parede e não são fornecidos. Em caso de dúvida, consulte um especialista.

Italian

IMPORTANTE: Per evitare il ribaltamento accidentale del mobile è obbligatorio il fissaggio a muro.

I tasselli necessari per il collegamento mobile\muro, dipendenti dal tipo di muro, non sono provvisti.

Consultare uno specialista in caso di dubbi

Croatian

VAŽNO: Kako bi se izbjeglo slučajno prevrtanje, namještaj je potrebno pričvrstiti na (uza) zid.

Različite vrste zidova zahtijevaju upotrebu različitih vrsta vijaka i tipli. Uvijek koristiti one koji su prikladni za vrstu zidova u domu. Vijci i tiple prodaju se zasebno.

U slučaju bilo kakvih sumnji, obratite se stručnjaku.

German

WICHTIG : Um ein versehentliches Kippen des Möbels zu vermeiden, ist die Befestigung an der Wand zwingend vorgeschrieben.

Die benötigten Schrauben zur Wandbefestigung, welche von der Beschaffenheit der Mauer abhängen, sind nicht in der Lieferung enthalten. Wenden Sie sich bitte bei Zweifel an einen Spezialisten.

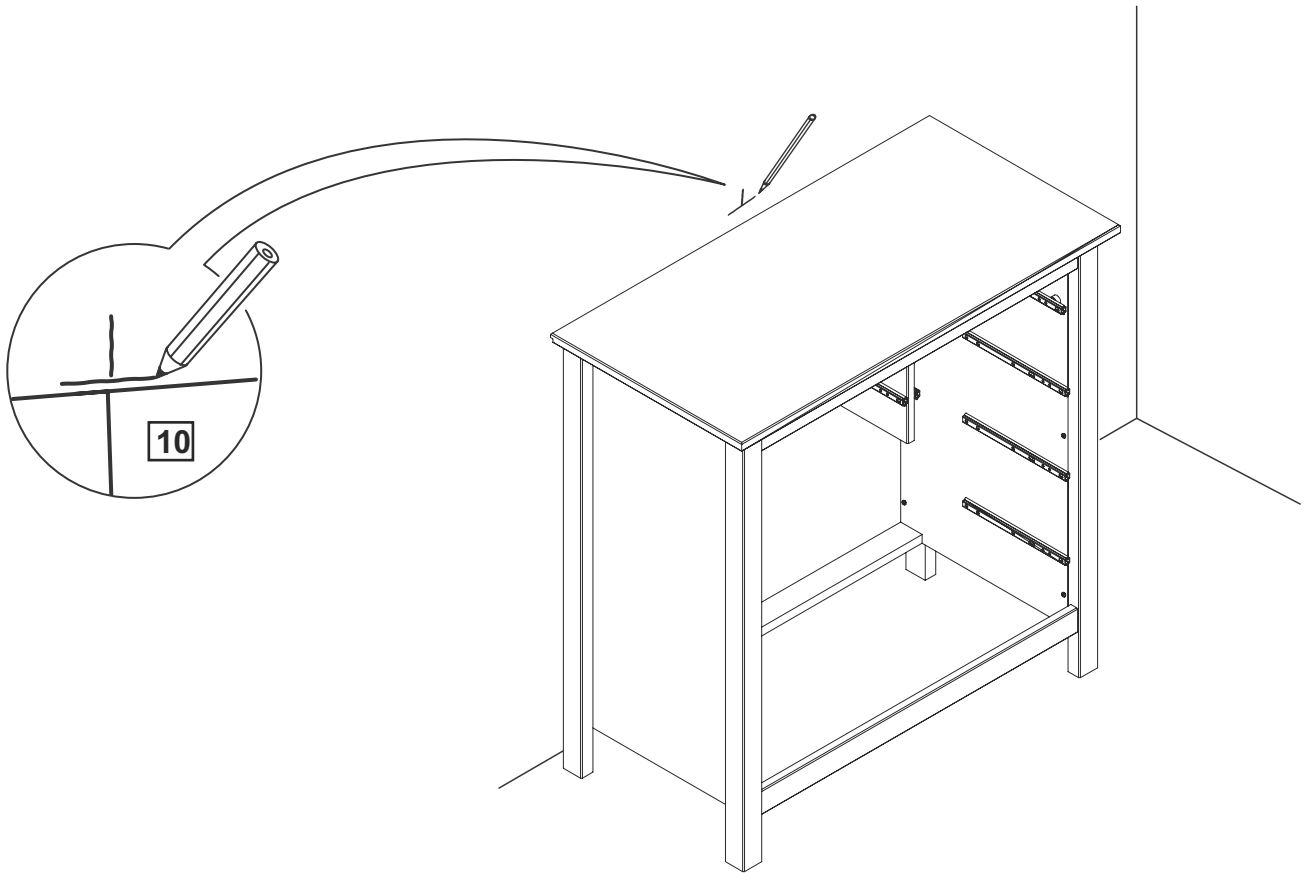

Il existe une grande diversité de types de murs ou cloisons, c'est la raison pour laquelle nous ne pouvons vous fournir le type exact de fixation. Il est nécessaire d'identifier le type de paroi à laquelle vous allez fixer ce produit afin de vous procurer les fixations appropriées. Voici quelques exemples de fixations conseillées pour:



LES MURS PLEIS

Cheville nylon "FISCHER"

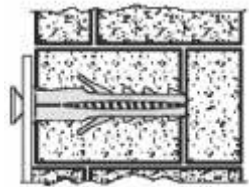
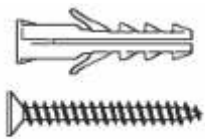

Cheville d'ancrage métal

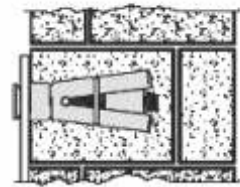
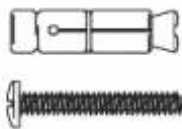

Cheville d'ancrage
A ailettes en nylon

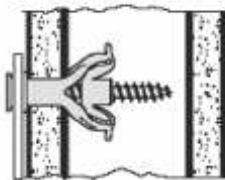
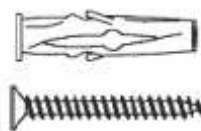

LES CLOISONS CREUSES

Cheville métallique
A expansion

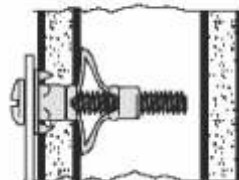
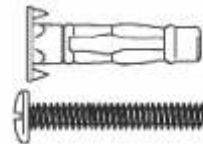

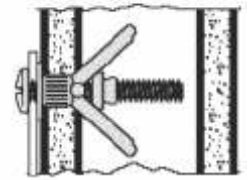
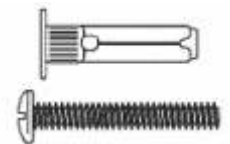

Cheville "MOLLY"



Utiliser une taille de forêt adaptée à la quincaillerie utilisée et au type de mur.

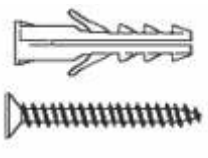
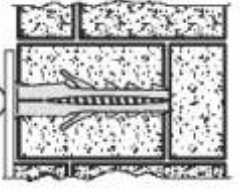
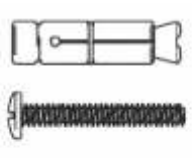
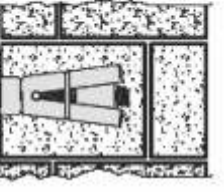
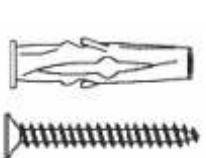
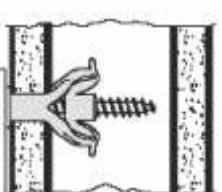
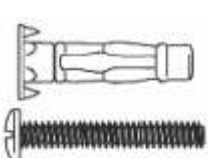
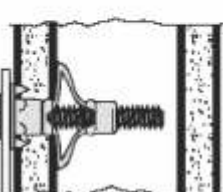

Due to the wide diversity of wall or partition types, we cannot provide you with suitable attachment fixtures. To determine which attachment fixtures to use, you will need to identify the type of wall to which you will be fixing this product. Here are some examples of attachment fixtures recommended for:

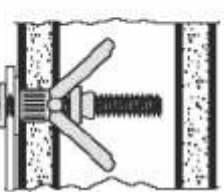

| BLIND WALLS | | STUDDED WALLS | | |
|--|---|--|--|--|
| <p>"FISCHER" Nylon plug</p>   | <p>Metal Wall plug</p>   | <p>Nylon winged Wall plug</p>   | <p>Metal expansion plug</p>   | <p>"MOLLY" plug</p>   |



Use a drill bit that is compatible in size with the hardware used and the type of wall.

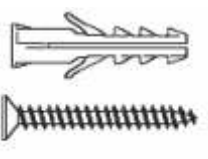
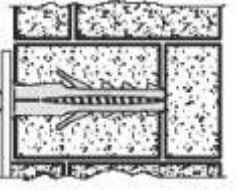
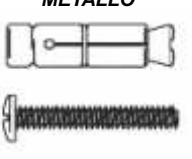
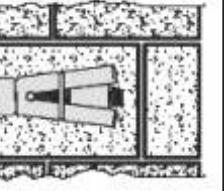
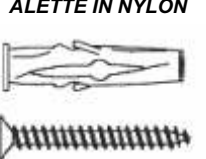
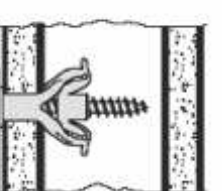
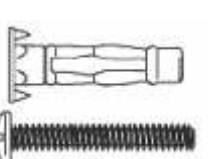
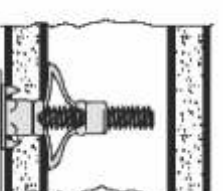

Esiste una gran varietà di tipi di muri o paratie e noi siamo in grado di fornirvi il tipo esatto di fissaggio per ognuno di essi. E' necessario identificare il tipo di parete alla quale intendete fissare questo prodotto in modo da fornirvi i fissaggi più idonei. Ecco qualche esempio di fissaggi consigliati per :

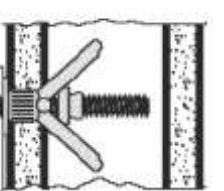
| I MURI PIENI | | PARATIE CAVE | | |
|--|---|---|--|--|
| <p>TASSELLO NYLON "FISCHER"</p>   | <p>TASSELLO DI ANCORAGGIO IN METALLO</p>   | <p>TASSELLO DI ANCORAGGIO AD ALETTE IN NYLON</p>   | <p>TASSELLO METALLICO AD ESPANSIONE</p>   | <p>TASSELLO "MOLLY"</p>   |



Utilizzare una punta di trapano adatta agli utensili utilizzati e al tipo di muro.



Es gibt eine Vielzahl verschiedener Arten von Mauern oder Zwischenwänden, und aus diesem Grunde können wir Ihnen den genau entsprechenden Befestigungstyp nicht bereitstellen. Zunächst ist es erforderlich, die exakte Bauart der Wand zu ermitteln, an der Sie dieses Produkt anbringen werden, um die für diese Wand geeigneten Befestigungsmittel im Fachhandel erwerben zu können. Nachfolgend einige Beispiele empfohlener Befestigungen für:



VOLLWÄNDE

NYLONDÜBEL „FISCHER“

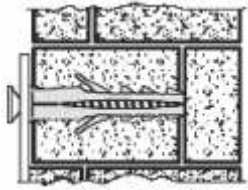
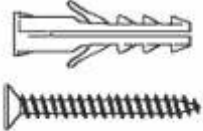

ANKERDÜBEL AUS METALL

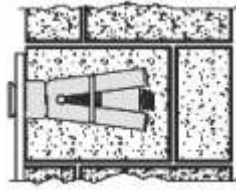
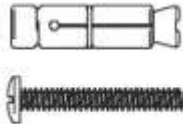

ANKERDÜBEL MIT NYLONFLÜGELN

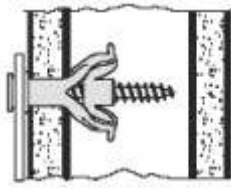
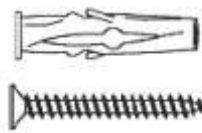

HOHLWÄNDE

SPREIZDÜBEL FÜR VERANKERUNG AUS METALL

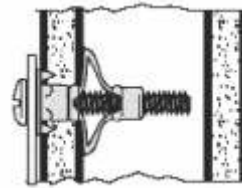
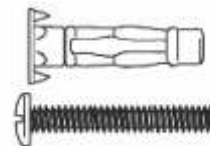

MOLLY-DÜBEL

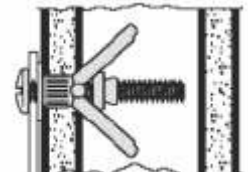

Bitte verwenden Sie eine für die Eisenwaren und den Wandtyp geeignete Bohrergröße.

11

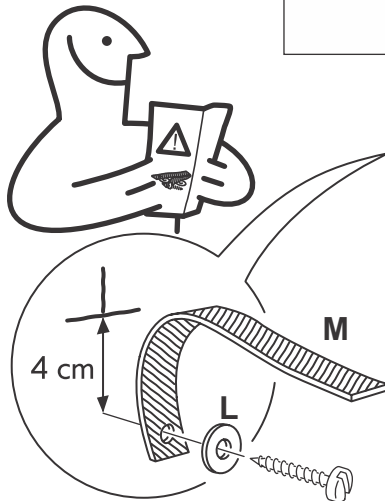
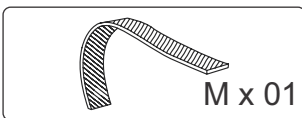
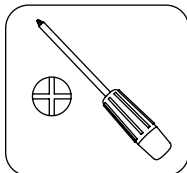

! FIXATION MURALE OBLIGATORIE !
! OBLIGATORIO FIJAR A LA PARED !
! OBLIGATORY FIX ON THE WALL !

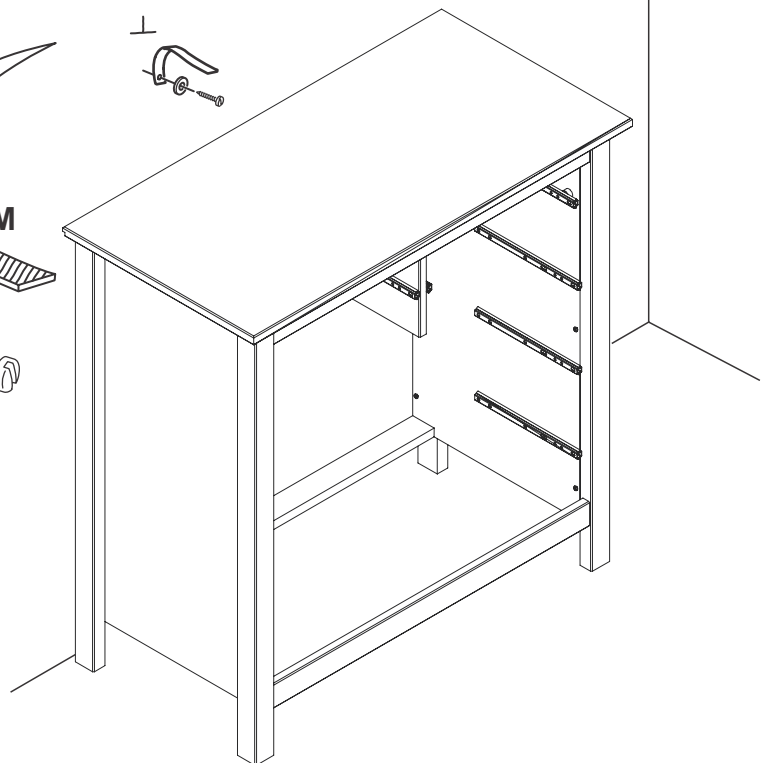

12

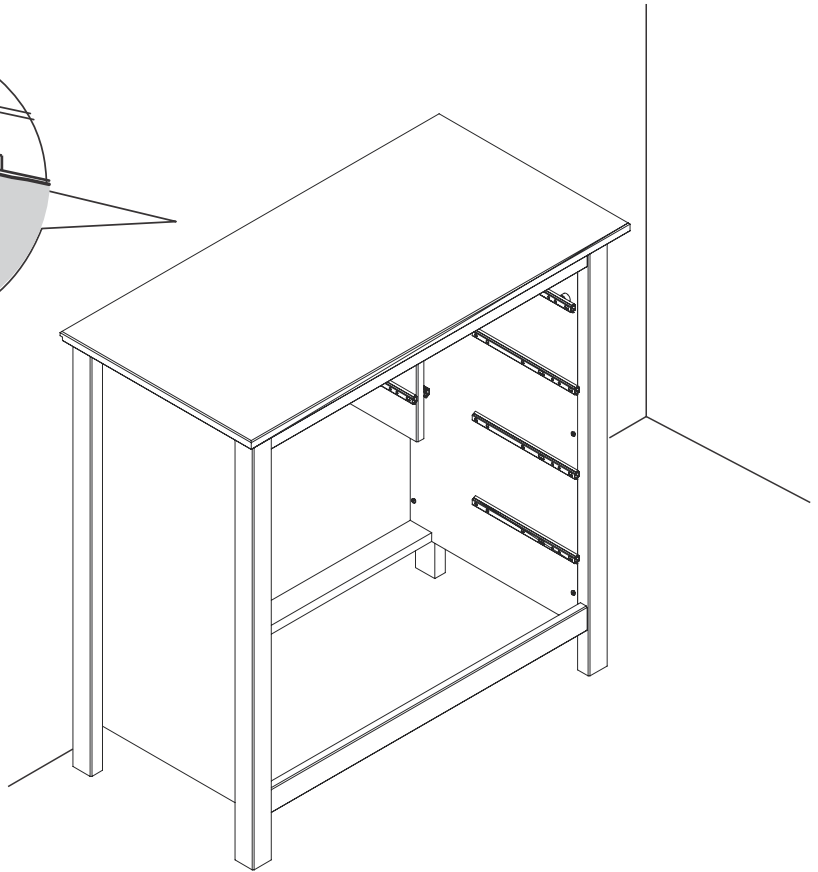
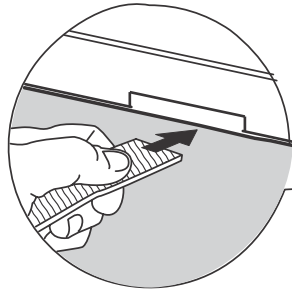

13

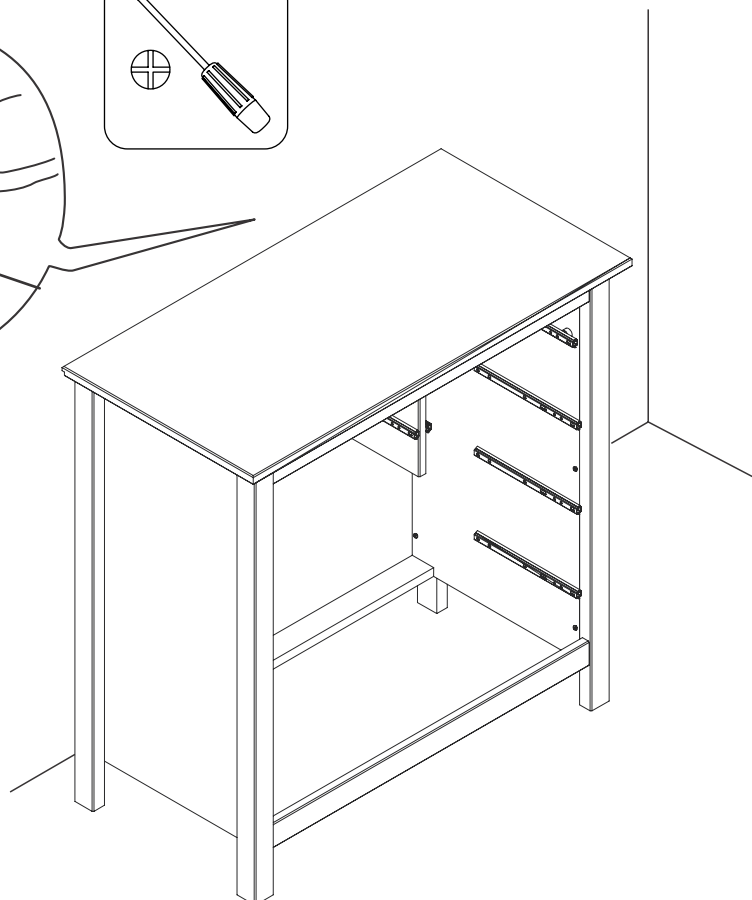
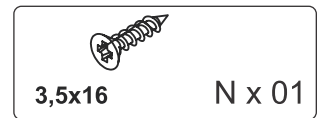
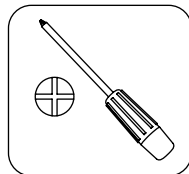
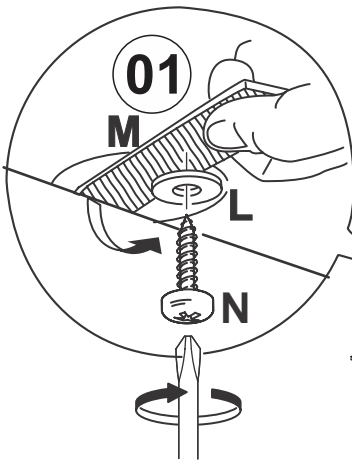

14

2x

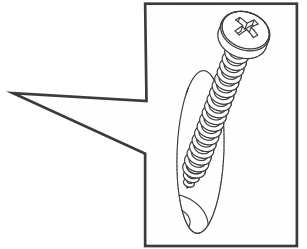
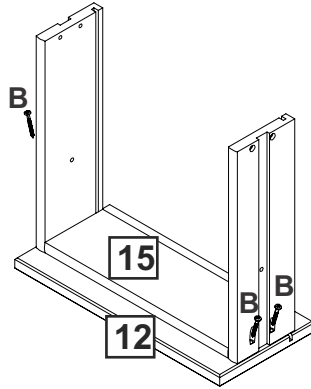
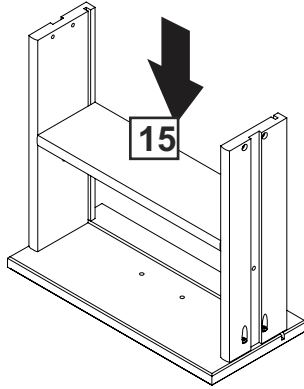
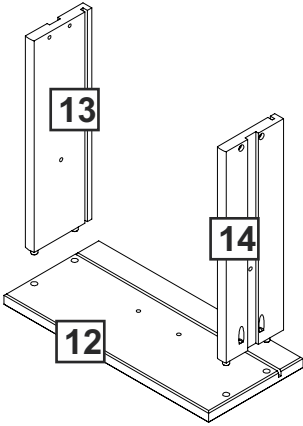
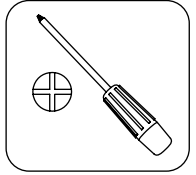
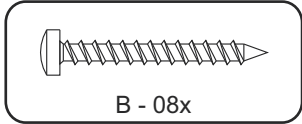

15

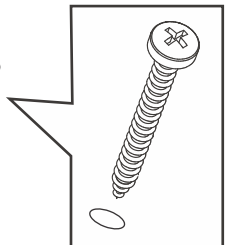
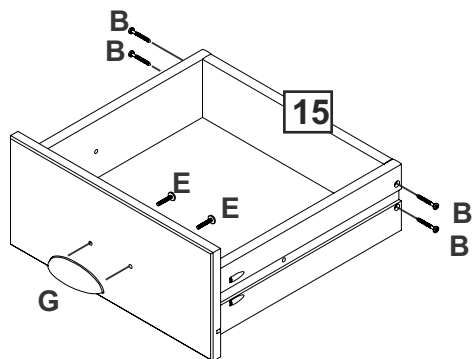
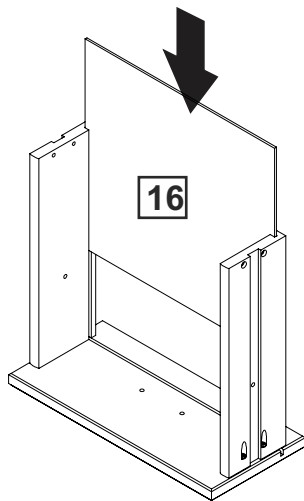
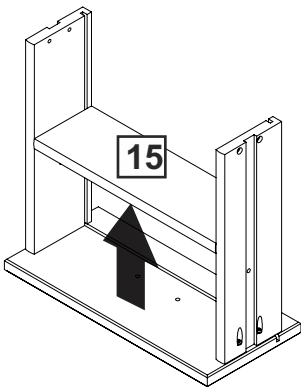
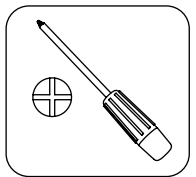
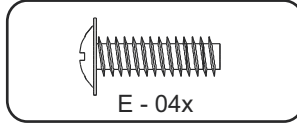
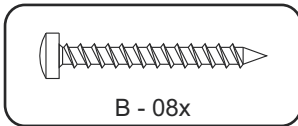

16

3x

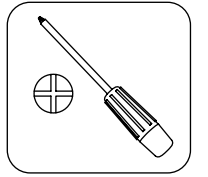
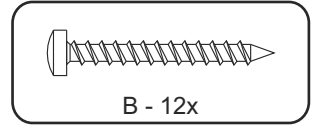
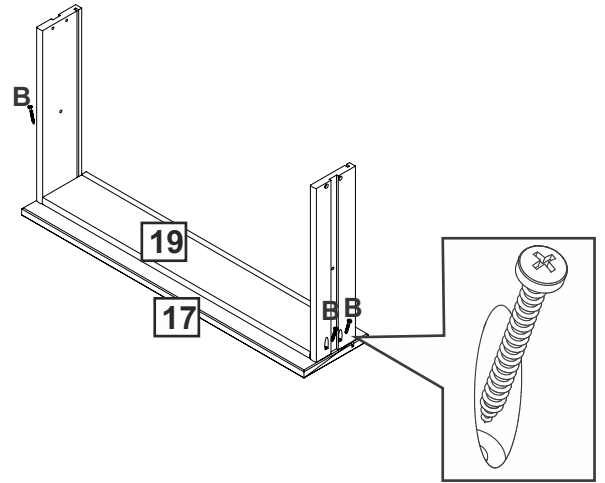
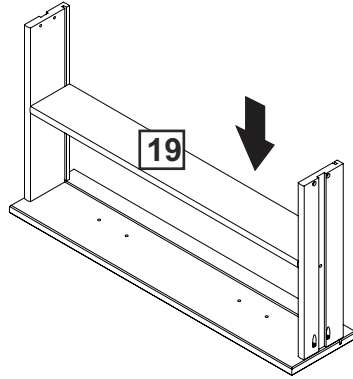
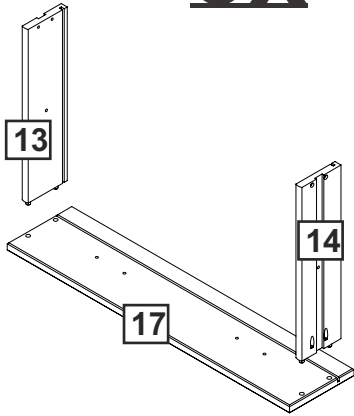

17

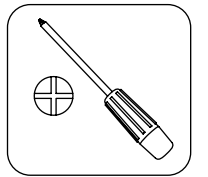
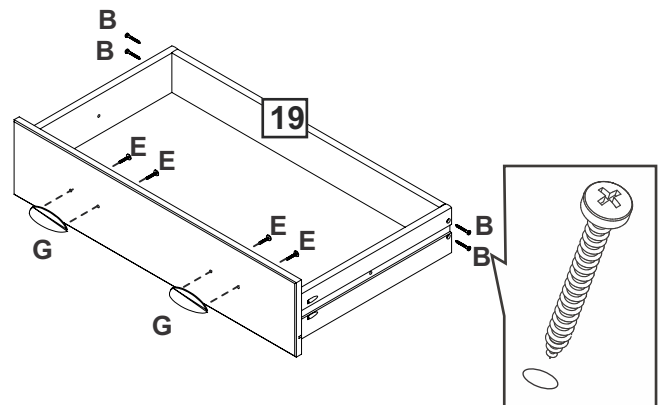
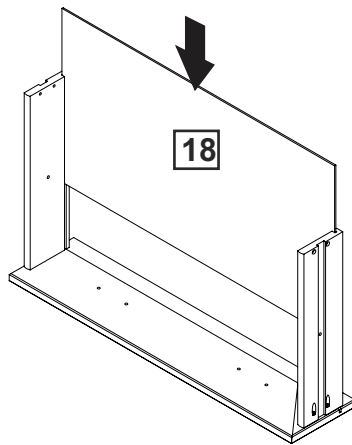
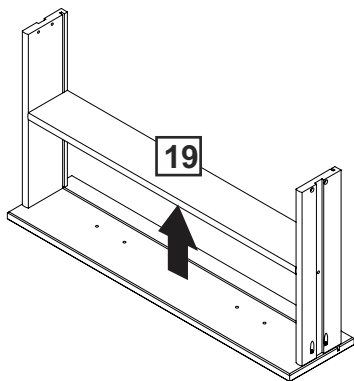
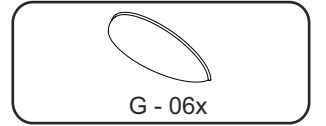
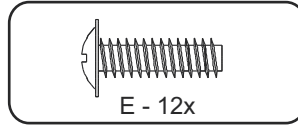
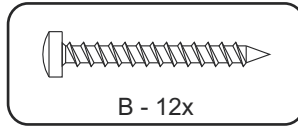

18

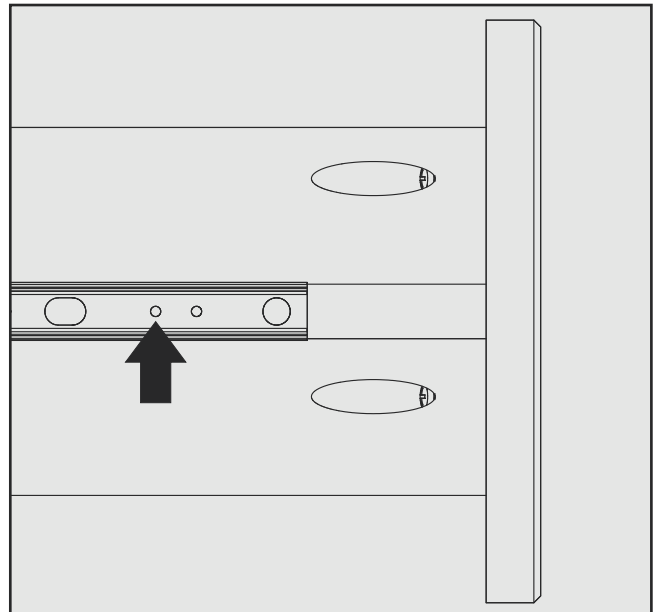
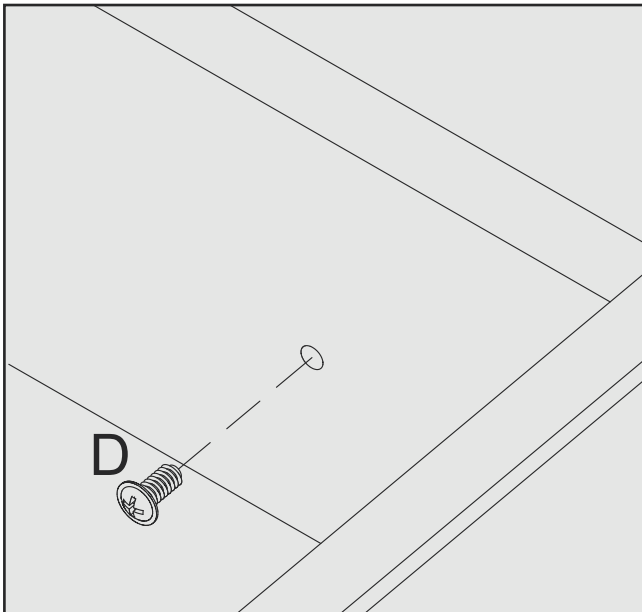
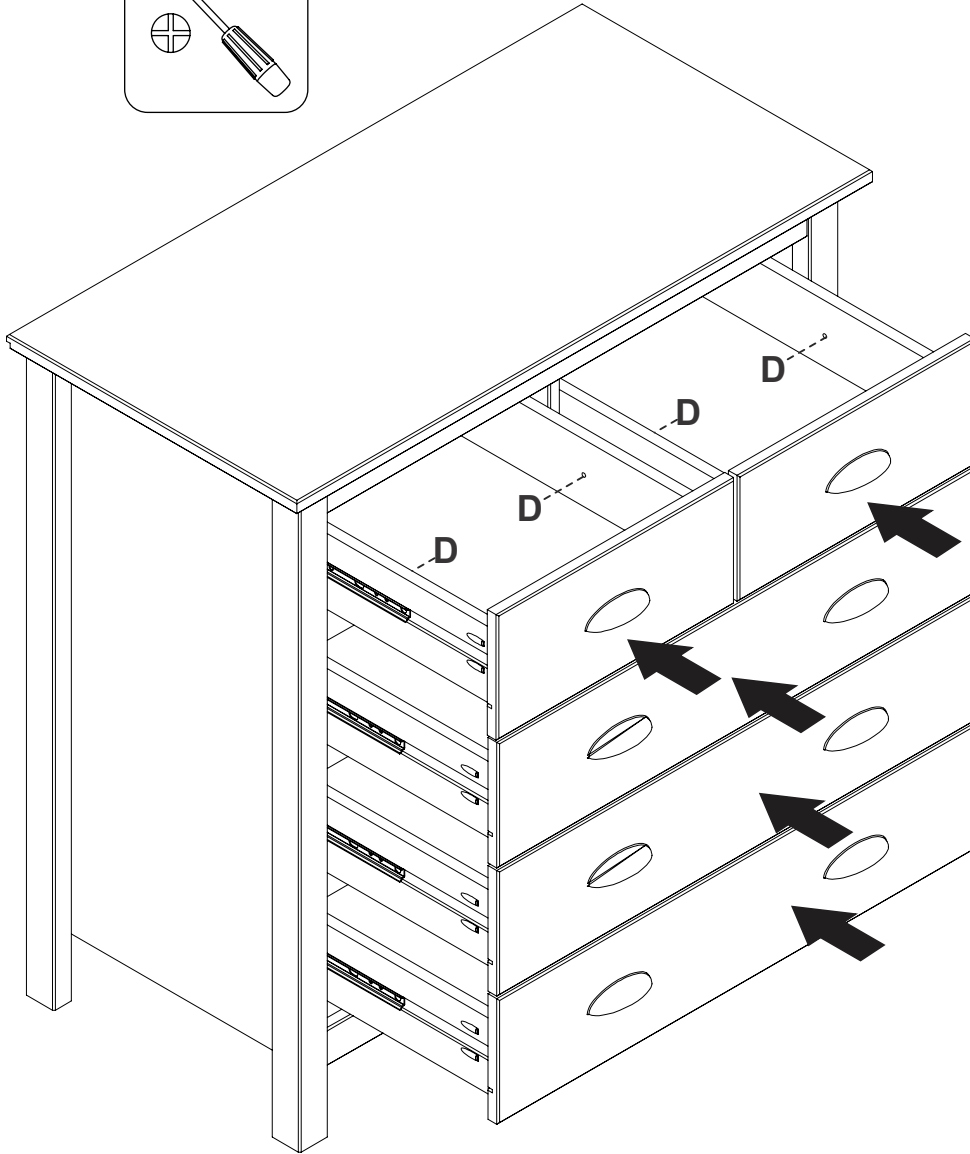
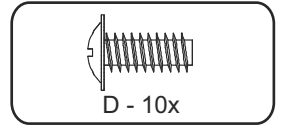
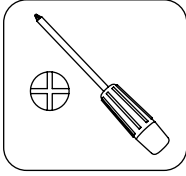

FRENCH: "Les meubles contenant des panneaux à base de bois (panneaux de particules, panneaux de fibres, contreplaqué...) peuvent émettre des substances polluantes dans l'air intérieur. Il est ainsi recommandé, après l'installation du meuble dans son logement, d'aérer fréquemment la pièce concernée pendant au moins quatre semaines afin de réduire son exposition aux polluants émis par le meuble."

SPANISH: Los muebles que contienen paneles a base de madera (Aglomerado, cartón, contrachapado ...) pueden emitir sustancias contaminantes en el aire. Por lo tanto, se recomienda airear frecuentemente los muebles al menos durante cuatro semanas después de su instalación para reducir su exposición a los contaminantes emitidos por los muebles.

ENGLISH: Furniture containing wood-based panels (Particle board, fibreboard, plywood ...) could emit pollutants on the air. Therefore, it is advisable to ventilate the furniture at least during four weeks after its assembly in order to reduce the exposure to the pollutants released by the furniture.

FRANCAIS - SUISSE

CONSEILS DE MONTAGE :

- 1 > BIEN ETUDIER LA NOTICE DE MONTAGE.
- 2 > REPEREZ LES PIÈCES CONSTITUANT VOTRE MEUBLE.
- 3 > REGROUPEZ ET CONTROLEZ LA QUINCAILLERIE.
- 4 > MUNISSEZ-VOUS DE L'OUTILLAGE NECESSAIRE.
- 5 > AMENAGEZ-VOUS UNE ZONE DE MONTAGE.
- 6 > PROCEDEZ AU MONTAGE.



**NE JAMAIS FORCER LES ASSEMBLAGES.
RESSERREZ LES VIS APRES QUELQUES TEMPS D'USAGE.
GARDER VOTRE NOTICE DE MONTAGE, SI UNE PIÈCE
VENAIT A MANQUER, ELLE SERAIT LE PLUS CLAIR
MOYEN DE COMMUNIQUER AVEC VOTRE MAGASIN.**

CONSEILS D'ENTRETIEN :

- 1 > DÉPOUSSIÉREZ SOIGNEUSEMENT.
- 2 > UTILISEZ UN CHIFFON SEC.



**- NE JAMAIS UTILISER
DE PRODUITS ABRASIFS:
POUDRE, LAINE D'ACIER, SOLVANTS.
- NE PAS MOUILLER**

| | PAPIER DECOR | SURFACES STRATIFIÉES | SURFACES LAQUÉES | BOIS VERNIS | TEXTILE CUIR |
|--------------------------------|-----------------|-------------------------|---------------------|----------------|-----------------|
| EAU SAVONNEUSE (SAVON NEUTRE) | ○ | ○ | ○ | ○ | ○ |
| EAU ADDITIO NÉE | | ○ | ○ | | |
| ENTRETIEN SPÉCIFIQUE FABRICANT | | | | | ○ |

DEUTSCH - SCHWEIZ

MONTAGE ANLEITUNG:

- 1 > DIE MONTAGEANLEITUNG SORGFÄLTIG DURCHLESEN.
- 2 > DIE EINZELTEILE DES MÖBELSTÜCKS ERMITTELN.
- 3 > DIE BESCHLÄGE ZUSAMMENLEGEN UND PRÜFEN.
- 4 > DAS NOTWENDIGE WERKZEUG ZURECHTLEGEN.
- 5 > EINEN MONTAGEBEREICH FREIMACHEN.
- 6 > DAS MÖBELSTÜCK ZUSAMMENBAUEN.



**NIEMALS DIE VERBINDUNGEN ZU STARK ANZIEHEN.
DIE SCHRAUBEN NACH EINIGER ZEIT DES GEBRAUCHS
ERNEUT FESTZIEHEN. DIE MONTAGEANLEITUNG
GUT AUFBEWAHREN: SOLLTE EIN TEIL FEHLEN, IST SIE DAS
BESTE VERSTÄNDIGUNGSMITTEL MIT IHREM GESCHÄFT.**

PFLEGEHINWEISE :

- 1 > SORGFÄLTIG ENTSTAUBEN.
- 2 > VERWENDEN SIE EIN TROCKENES TUCH.



**- BENUTZEN SIE KEINE
SCHEUERMITTEL WIE PULVER,
STAHLWOLLE, LÖSUNGSMITTEL.
- KEIN WASSER VERWENDEN.**

| | DEKORPAPIER | OBERFLÄCHE LAMINAT | OBERFLÄCHE LACK | LACKIERTEM HOLZ | TEXUL LEDER |
|----------------------------------|-------------|-----------------------|--------------------|--------------------|----------------|
| SEIFENLAUGE (NEUTRALSEIFE) | ○ | ○ | ○ | ○ | ○ |
| WASSER MIT HAUSHALTSRFINIGER | | ○ | ○ | | |
| PRODUZENT SPEZIFISCHER UNTERHALT | | | | | ○ |

ITALIANO - SVIZZERA

CONSIGLI DI MONTAGGIO

- 1 > STUDIARE BENE LE ISTRUZIONI DI MONTAGGIO.
- 2 > PRENDERE CONOSCENZA DEI PEZZI CHE COSTITUISCONO IL MOBILE.
- 3 > RAGGRUPPARE E CONTROLLARE LA FERRAMENTA.
- 4 > MUNIRSI DEGLI UTENSILI NECESSARI.
- 5 > PREPARARE UNA ZONA DI MONTAGGIO.
- 6 > PROCEDERE AL MONTAGGIO.



**NON FORZARE MAI GLI ASSEMBLAGGI
RISTRINGERE LE VITI DOPO UN PERIODO D'USO
CONSERVARE QUESTE ISTRUZIONI DI MONTAGGIO,
SE UN PEZZO VENISSE A MANCARE SAREBBE IL MIGLIORE
MEZZO DI COMUNICAZIONE CON IL RIVENDITORE**

CONSIGLI PER LA MANUTENZIONE :

- 1 > SPOLVERATE ACCURATAMENTE.
- 2 > USARE UN PANNINO ASCIUTTO.



**- NON UTILIZZARE MAI PRODOTTI
ABRASIVI: POLVERE,
LANA DI ACCIAIO, SOLVENTI.
- NON BAGNARE.**

| | CARTA | SUPERFICIE STRATIFICATE | SUPERFICIE LACCATE | LACCATE EGNO VERNICIATO | TESSILE CUOIO |
|-----------------------------------|-------|----------------------------|-----------------------|----------------------------|------------------|
| ACQUA CON SAPONE (SAPONE NEUTRO) | ○ | ○ | ○ | ○ | ○ |
| ACQUA CON DETERSIVO SAN MARC | | ○ | ○ | | |
| MANUTENZIONE SPECIFICA PRODUTTORE | | | | | ○ |

PORTUGUÊS

CONSELHOS DE MONTAGEM:

- 1 > ESTUDE BEM AS INSTRUÇÕES DE MONTAGEM.
- 2 > REUNA AS PEÇAS QUE CONSTITUEM O SEU MÓVEL.
- 3 > REAGRUPE AS FERRAGENS.
- 4 > EQUIPE-SE COM AS FERRAMENTAS NECESSÁRIAS.
- 5 > PREPARE UMA ÁREA PARA A MONTAGEM.
- 6 > INICIE A MONTAGEM.



**NUNCA FORÇAR OS ENCAIXES.
REAPERTAR OS PARAFUSOS APÓS UM TEMPO DE UTILIZAÇÃO.
GUARDAR AS INSTRUÇÕES DE MONTAGEM.
CASO FALTE ALGUMA PEÇA, O MAIS ACONSELHÁVEL
É CONTATAR O REVENDEDOR.**

CONSELHOS PARA A MANUTENÇÃO :

- 1 > ELIMINAR BEM O PÓ.
- 2 > USAR PANO SECO.



**- NUNCA UTILIZAR PRODUTOS
ABRASIVOS: SAPONÁCEOS,
LÃ DE AÇO, SOLVENTES.
- NÃO MOLHAR .**

| | ACABAMENTO IMITAÇÃO | SUPERFÍCIES ESTRATIFICADAS | SUPERFÍCIES LACADAS | MADEIRA ENVERNIZADA | TEXTEIS PELES |
|--------------------------------------|------------------------|-------------------------------|------------------------|------------------------|------------------|
| ÁGUA COM SABÃO (SABÃO NEUTRO) | ○ | ○ | ○ | ○ | ○ |
| ÁGUA COM DETERGENTE | | ○ | ○ | | |
| INSTRUÇÕES ESPECÍFICAS DO FABRICANTE | | | | | ○ |

ESPAÑOL

CONSEJOS PARA EL MONTAJE:

- 1 > ESTUDIE ATENTAMENTE EL MANUAL DE MONTAJE.
- 2 > LOCALICE LAS PIEZAS QUE CONSTITUYEN SU MUEBLE.
- 3 > REUNA Y CONTROLE LOS TORNILLOS.
- 4 > EQUIPE-SE DE LAS HERRAMIENTAS NECESARIAS.
- 5 > PREPARE UNA ZONA DE MONTAJE.
- 6 > REALICE EL MONTAJE.



**NO FUERCE NUNCA EN LAS UNIONES. APRIETE LOS
TORNILLOS DESPUES DE CIERTO TIEMPO DE UTILIZACION
CONSERVE SU MANUAL DE MONTAJE,
SI FALTARA UNA PIEZA, SERIA LA MANERA
MAS FACIL DE COMUNICAR CON LA TIENDA.**

CONSEJOS PARA EL MANTENIMIENTO:

- 1 > DESPOLVOREAR CULDADOSAMENTE.
- 2 > UTILICE UN PAÑO SECO.



**- NO USE NUNCA PRODUCTOS
ABRASIVOS TALES COMO:
POLVO DE LIMPIAR,
LANA DE ACERO, SOLVENTES.
- NO MOJAR.**

| | PAPEL DE DECORACION | SUPERFICIE ESTRATIFICADAS | SUPERFICIE MAQUEADAS | MADERA BARNIZADA | TEXTILL CUERO |
|---|------------------------|------------------------------|-------------------------|---------------------|------------------|
| AGUA Y JABON (JABON NEUTRO) | ○ | ○ | ○ | ○ | ○ |
| AGUA COM DETERGENTE | | ○ | ○ | | |
| MANTENIMIENTO ESPECIFICO DEL FABRICANTE | | | | | ○ |

HRVATSKA

UPUTE ZA MONTAŽU:

- 1 > PAŽLJIVO PROČITAJTE UPUTE ZA MONTAŽU.
- 2 > PRIPREMITE SVE DIJELOVE NAMJEŠTAJA.
- 3 > PRIKUPITE I PROVJERITE OKOVE ZA MONTAŽU.
- 4 > PRIPREMITE POTREBAN ALAT.
- 5 > PRIPREMITE PROSTOR ZA MONTAŽU.
- 6 > POČNITE MONTIRATI.



**NEMOJTE UPOTREBLJAVATI SILU PRILIKOM SKLAPANJA
NAKON NEKOG VREMENA PONOVRNO PRITEGNITE VIJKE
ČUVAJTE UPUTE ZA MONTAŽU
U SLUČAJU NEDOSTATKA NEKOG DIJELA NAJBOLJE ĆE BITI DA
DA KONTAKIRATE PRODAJNO MJESTO.**

UPUTE ZA ODRŽAVANJE :

- 1 > PAŽLJIVO OBRISATI PRAŠINU.
- 2 > KORISTITE SUHU KRPU.



**- ZABRANJENA JE UPOTREBA
KEMIKALIJA ILI BILO KAKVIH
POMOĆNIH SREDSTAVA ZA RIBANJE
JAKIH SREDSTAV ZA ČIŠĆENJE ILI
ČELIČNE VUNE
-NE MOKRA.**

| | PAPIR | LAMINAT | LAK | DRVO | TEKSTIL/ KOŽA |
|--------------------|-------|---------|-----|------|------------------|
| OTPINA SAPUNA | ○ | ○ | ○ | ○ | ○ |
| OTPINA DETERDŽENTA | | ○ | ○ | | |
| NAMJENSKA SREDSTVA | | | | | ○ |

TÜRÇE

MONTAJ TALIMATLARI:

- 1 > MONTAJ TANITIM YAZISINI DIKKATLICE OKUYUNUZ .
- 2 > MOBİLİYANIZI OLUŞTURAN PARÇALARI İŞARETLEYİNİZ.
- 3 > HIRDAVATLA İLGİLİ PARÇALARI BİR ARAYA TOPLAYIP; KONTROL EDİNİZ.
- 4 > GEREKEN ARAÇ VE GEREÇİ TEDARİK EDİNİZ.
- 5 > (KENDİNİZE) BİR MONTAJ ALANI EDİNİNİZ.
- 6 > MONTE ETMEYE BAŞLAYINIZ.



**MONTAJLARI ZORLAMAYINIZ.
BİRKAÇ KULLANIMDAN SONRA VIDALARI SIKIŞTIRINIZ.
BİR PARÇANIN KAYBOLMASI DURUMUNDA MAGAZANIZLADAHA
KOLAY İLETİŞİME GEÇEBİLMENİZ İÇİN MONTAJ KULLANIM
TALIMATINIZI SAKLAYINIZ.**

BAKIM TALIMATLARI:

- 1 > TOZUNU DIKKATLICE ALINIZ.
- 2 > YUMUŞAK BİR BEZİ TEMİZ SU VE AZ MIKTARDA SABUNLA(DETERJAN) NEMLENDİRİNİZ.



**ASLA AŞINDIRICI ÜRÜNLER
KULLANMAYINIZ : ÇELİK YÜNÜ,
SOLVENT...
BOL SUYLA YIKAMAYINIZ.**

| | SÜS KAGIDI | KATMAN YÜZEY | LAKE YÜZEY | CILALI TAHTA | TEKSTİL DERİ |
|-------------------------|------------|-----------------|---------------|-----------------|-----------------|
| SABUNLU SU (NOTR SABUN) | ○ | ○ | ○ | ○ | ○ |
| DETERJAN KATILMIŞ SU | | ○ | ○ | | |
| ÜRETİCİYE ÖZGÜ BAKIM | | | | | ○ |

ENGLISH

ASSEMBLY ADVICE :

- 1 > CAREFULLY READ THE ASSEMBLY INSTRUCTION.
- 2 > IDENTIFY THE COMPONENTS OF THE FURNITURE.
- 3 > GROUP AND CHECK THE HARDWARE.
- 4 > USE THE REQUIRED TOOLS.
- 5 > CREATE AN ASSEMBLY ZONE.
- 6 > MAKE THE ASSEMBLY.



**NEVER FORCE THE CONNECTIONS.
RE-TIGHTEN THE SCREWS AFTER FEW DAYS.
PLEASE RETAIN THE AI LEAFLET FOR FUTURE REFERENCE,
THE AI CONTAINS INFORMATION WHEN CLAIMING
FOR MISSING PARTS.**

CLEANING ADVICE:

- 1 > CAREFULLY REMOVE THE DUST.
- 2 > USE A SOFT, CLEAN DAMP CLOTH WITH SOAPY WATER.



**NEVER USE ABRASIVE PRODUCTS
OR SOLVENTS.
DO NOT APPLY EXCESSIVE PRESSURE
WHEN USING THE DAMP CLOTH.**

| | PAPER DECOR | LAMINATED SURFACES | LACQUERED SURFACE | VARNISHED WOOD | LEATHER TEXTILE |
|----------------------------|-------------|-----------------------|----------------------|-------------------|--------------------|
| SOAPY WATER (NEUTRAL SOAP) | ○ | ○ | ○ | ○ | ○ |
| WATER WITH DETERGENT | | ○ | ○ | | |
| SPECIFIC SUPPLIER CLEANING | | | | | ○ |

